

# FUJIIRYŌKI

## Instruction Manual 使用说明书

Thank you very much for purchasing our product.  
This "Instruction Manual" describes important items  
for use. Fully read and understand this Manual  
before use in order to use the product correctly.

非常感谢您购买本公司的产品。  
此说明书中记载了使用时需要注意的重要事项。  
请在使用前详细阅读，然后正确使用。  
阅读完后，请与附页中的“保修书”一同保管好。

## HWP-77EN HWP-77JP

Alkaline Water Ionizer  
碱性离子水生成器

For household use only

家庭装

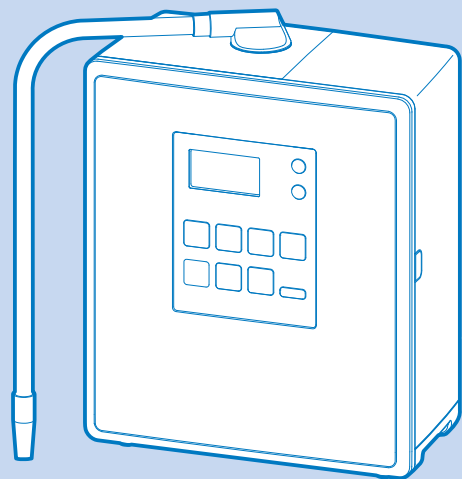

Our website has English and Chinese version of the Instruction Manual.

我们的网站有英文和中文版的使用说明书。



<https://www.fujiiryoki.com/>













<b>Contents</b>		
Safety precautions (Make sure to observe) .....	4	Introduction
Before use .....	8	
Name of each part .....	9	
How to mount corporation stop .....	13	Method of mounting
Installation of main body .....	16	
Using alkaline ionized water, acidic water and purified water .....	19	How to use
When pH value of alkaline ionized water is low .....	22	
Switch display .....	23	
Confirming filter life .....	24	
Generation of sanitized water .....	25	
Precautions for use .....	27	
Measuring pH value .....	28	
Cleaning inside of the main body .....	29	Maintenance
Maintenance .....	30	
Anti-freezing .....	30	
Filter replacement .....	31	
When any of the following indications appear .....	34	Other
When failure is suspected .....	35	
Specifications .....	38	
<b>目录</b>		
为了安全使用，请务必遵守 .....	40	开始
使用前 .....	44	
各部件的名称 .....	45	安装方法
分歧栓的安装方法 .....	49	
主机的设置 .....	52	
使用碱性离子水，酸性水，净水 .....	55	使用方法
碱性离子水的 pH 值偏低时 .....	58	
画面切换 .....	59	
查看滤芯的使用寿命（剩余量） .....	60	
酸化水的生成 .....	61	
使用时的注意点 .....	63	
测定 pH 值 .....	64	
主机内部的清洗 .....	65	维护
维护 .....	66	
关于防止冻结 .....	66	
滤芯的更换 .....	67	
如果出现如下显示内容时 .....	70	其他
感觉发生故障时 .....	71	
规格 .....	74	
产品中有害物质的名称及含量 .....	75	

# Safety precautions (Make sure to observe)

- The precautions described here are intended for you to use the product safely and correctly, and prevent hazards or injury to you and other persons before they occur.
- The precautions are classified as follows.  
All of the items are related to safety and important matters, therefore, make sure to observe them.













 <b>WARNING</b>	Extent of hazard that improper operation is predicted to result in death or serious injury to users.
 <b>CAUTION</b>	Extent of hazard or damage that improper operation is predicted to result in injury to users or physical damage.

## <Example of pictorial indication>

	<p> symbol indicates “Prohibited” (do not perform).</p> <p> “Disassembly prohibited”    “Use in a place with water prohibited”</p> <p> “Keep dry”    “Wet hands prohibited”    “Keep fire away”</p>
	<p> symbol indicates “Mandatory” (make sure to perform).</p> <p> “General action”</p> <p> “Remove the power plug from the power outlet”</p>

- After reading, make sure to keep this Manual in an easy to access location where users can refer to it at any time.

**⚠ WARNING**

 Prohibited	Do not use water unsuitable for human consumption. (Poor physical condition may result.)
	Do not use this product by any method exceeding the rating of power outlet or wiring appliance and at power supply other than an alternating current of 110-240V. (Fire or electric shock may result.)
	Do not damage the power cord or power plug. - Do not fix with a staple  - Do not compromise  - Do not rework - Do not forcibly bend  - Do not twist  - Do not pull - Do not bring close to thermal appliance  - Do not put any heavy objects on top - Do not bundle  - Do not sandwich (Use with damage may result in electric shock, short-circuit or fire.) <ul style="list-style-type: none"> <li>• When removing the power plug, hold the power plug without holding the cord.</li> <li>• Consult with the store where you purchased this product to repair the power cord or the power plug.</li> </ul>
	When the power cord or the power plug are damaged, or the plug is loosely inserted into the power outlet, do not use. (Electric shock, short-circuit or ignition may result.)
 Make sure to observe	If you accidentally drop the main body in water, remove the power plug from the power outlet, and remove the main body from the water. (Electric shock may result.) <ul style="list-style-type: none"> <li>• Make sure to consult with the store where you purchased this product for repair.</li> </ul>
	Remove dust adhered to the power plug. (Accumulation of dust on the power plug may cause insulation failure due to moisture, resulting in fire.) <ul style="list-style-type: none"> <li>• Remove the power plug from the power outlet, and wipe off dust with a dry cloth.</li> </ul>
	Completely insert the power plug into the power outlet. (Insufficient insertion may result in electric shock and fire due to heat generation.)
 Remove the power plug	When performing maintenance, make sure to remove the power plug from the power outlet. (Electric shock may result.)
 Keep dry	Do not wash main body with water and do not splash water. (Electric leakage or electric shock may result.)
 Use in a place with water prohibited	Do not use this product in a humid place such as a bathroom. (Electric leakage or electric shock may result.)
 Wet hands prohibited	Do not insert or remove the power plug with wet hands. (Electric shock may result.)
 Disassembly prohibited	Never remodel, disassemble or repair this product. (Fire or electric shock may result.) <ul style="list-style-type: none"> <li>• Consult with the store where you purchased this product for repair.</li> </ul>

# Safety precautions (Make sure to observe)

## ⚠ CAUTION



Make sure  
to observe

Persons described below should consult with a doctor before drinking alkaline ionized water.

- A person who has any chronic disease, is weak in body or feels any abnormality in body.
- A person who is receiving medical treatment from a doctor, in particular, has a problem with kidneys.

When you feel any abnormality from drinking alkaline ionized water, stop using and consult with a doctor.

A person who drinks for the first time should set to Alkaline 1 (rough standard : pH8.5), drink little-by-little (one or two cups), and increase pH value and amount according to physical condition after getting used to alkaline ionized water.

- If drinking or using strong alkaline ionized water of high pH initially, you may suffer from a poor physical condition.

Persons described below should consult with a doctor before using acidic water.

- A person with sensitive skin.    - Allergic person.

When feeling any abnormality with your skin by using acidic water, stop using and consult with a doctor.

Use alkaline ionized water, purified water and acidic water immediately after generating. When reserving, put water into a clean enclosed container and use it within two days after storing in a refrigerator.

- Because disinfection agent (such as chlorine) is removed in alkaline ionized water and purified water, bacteria tends to increase, therefore, you may suffer from a poor physical condition when drinking and using water which has been stored for a long time.

Pass water (approximately one liter) before use until the marks on the LCD monitor change from “flashing” to “lit” and “beeping” sound is emitted at the beginning of daily use. If not used for two days or longer, pass water for two minutes or longer before use even after the marks on the LCD monitor changes to “lit” and “beeping” sound is emitted.

A person with a kidney disease (kidney failure and potassium excretion disorder) should not drink alkaline ionized water.

Do not take medicinal drugs with alkaline ionized water.

Do not directly drink water of pH10 or more (strong alkaline ionized water). (Poor physical condition may result.)

- It is recommended to drink water of Alkaline 3 (rough standard : pH9.5) (daily use). Amount of drinking for one day should be 0.5 liters to 1 liter as a rough standard.

Do not drink water described below. (Poor physical condition may result.)

- Acidic water    - Water coming out from the drain hose    - Water during cleaning
- Sanitized water

Do not use anything other than the included pH test liquid.

- Use the accessories or separately sold product.



Do not use aluminum containers sensitive to alkaline and copper containers sensitive to acid.

- Discoloration or damage to the containers may result.



Prohibited

## ⚠ CAUTION

 Prohibited	<ul style="list-style-type: none"> <li>Do not flow hot water of 35°C or higher to the main body. (Failure may result.)</li> <li>Do not flow hot water of 60°C or higher to the corporation stop. (Burn injury or failure may result.)</li> </ul>
	Do not use alkaline ionized water, acidic water or purified water as breeding water for fish. Change in environment may cause fish to die.
	Do not drink water containing pH test liquid or test liquid, or do not put into eyes. (Poor physical condition may result.)
	Do not drink water while the “Cleaning”, “Rinsing” or “Preparing” mark is indicated. (Poor physical condition may result.)
	Never drink sanitized water because it is a strong acidic water of approximately pH2.5. (Poor physical condition may result.)
	When feeling any abnormality with your body by using sanitized water, immediately stop use and consult with a doctor.
	Do not add any salt other than usable salt in the salt case. (Failure may result.) Refer to the “Usable salt” on page 27 for salt that can be used.
	Do not store sanitized water. (Generated chlorine may result in poor physical condition.)
 Keep fire away	Do not soak metallic dishes or rings in sanitized water. (Rust and discoloration may result.)
	As the pH test liquid contains alcohol, do not bring it close to fire. (Fire may result)
 Make sure to observe	After installation and if not used for a long time (rough standard:one week or longer), make sure to measure pH value with the included pH test liquid, and confirm that the water of Alkaline 3 (rough standard : pH9.5) does not exceed pH10 before use. Periodically measure it after that (more frequently than once a month).
	When removing the power plug from the power outlet, make sure to hold the power plug without holding the power cord. (Electric shock, short-circuit or ignition may result.)
	When not in use for a long time (one week or longer as a rough standard), make sure to remove the power plug from the power outlet.
	When generating, using or draining sanitized water, use in a well-ventilated place by turning on a ventilation fan or opening a window because a chlorine odor occurs. (Poor physical condition may result.)
	If sanitized water or water coming from the drain hose gets into your eyes, immediately rinse eyes out with a plenty of tap water. (Poor physical condition may result.)
	After generating, using or draining sanitized water in a stainless steel sink, rinse out sink with tap water. (Discoloration of sink may result.)
	When sanitized water splashes on clothing or hair, rinse clothing or hair off with tap water. (Discoloration may result.)

# Before use

For optimal use

## ● Proper use of 4 kinds of water For optimal use according to application

			Application	Rough Standard of pH value
pH adjustment button	Alkaline ionized water	Strong	For washing vegetables and cooking ingredients with a lot of scum. (⚠CAUTION) Do not drink directly.	10~11
		3	For daily drinking, making coffee, tea, cooking.	9~9.9
		2	For becoming accustomed to drinking, for cooking rice.	8.5~9.5
		1	For first time use.	8~9
	Purify water	Water filtered by filter. For taking medicinal drugs, preparing milk and drinking. ※This water is not electrolyzed.	—	
Acidic water	For washing your face. (⚠CAUTION) Do not drink.	4.5~6.5		
Sanitized water			For passing water and cleaning and disinfection. (⚠CAUTION) Do not drink.	2.5~3.5

### ● Built-in “No discharge water mode”

There is no discharge water at the start of generation while the “No discharge water” lamp is lit, and you can use it immediately.

### ● Easily visible digital display

The water in use can be checked at a glance by the LCD monitor.

The LCD monitor shows the pH, dissolved hydrogen concentration, total flow rate, and remaining usable filter amount.

### ● Built-in “Hydrogen plus mode” and “Hi mode” which increase electrolytic capacity at the press of a button

This is easily set in a region where pH value is difficult to increase.

Use the “Hydrogen plus mode” when the measured pH value is lower than the rough standard for pH values displayed on the LCD monitor.

Use the “Hi mode” if the measured pH value does not reach the rough standard range even when using the “Hydrogen plus mode.”

※The amount of the pH value increase depends on water quality and operating conditions.

#### ● What is pH of water?

pH represents the concentration of hydrogen ions in water and is an index representing whether water is alkaline or acidic.

Acidic                      Neutral                      Alkaline  
 (Smaller numerical value) ← (7) → (Larger numerical value)

#### ● What is dissolved hydrogen concentration?

Dissolved hydrogen concentration represents a rough standard of the hydrogen amount in the generated alkaline ionized water by electrolysis of water.







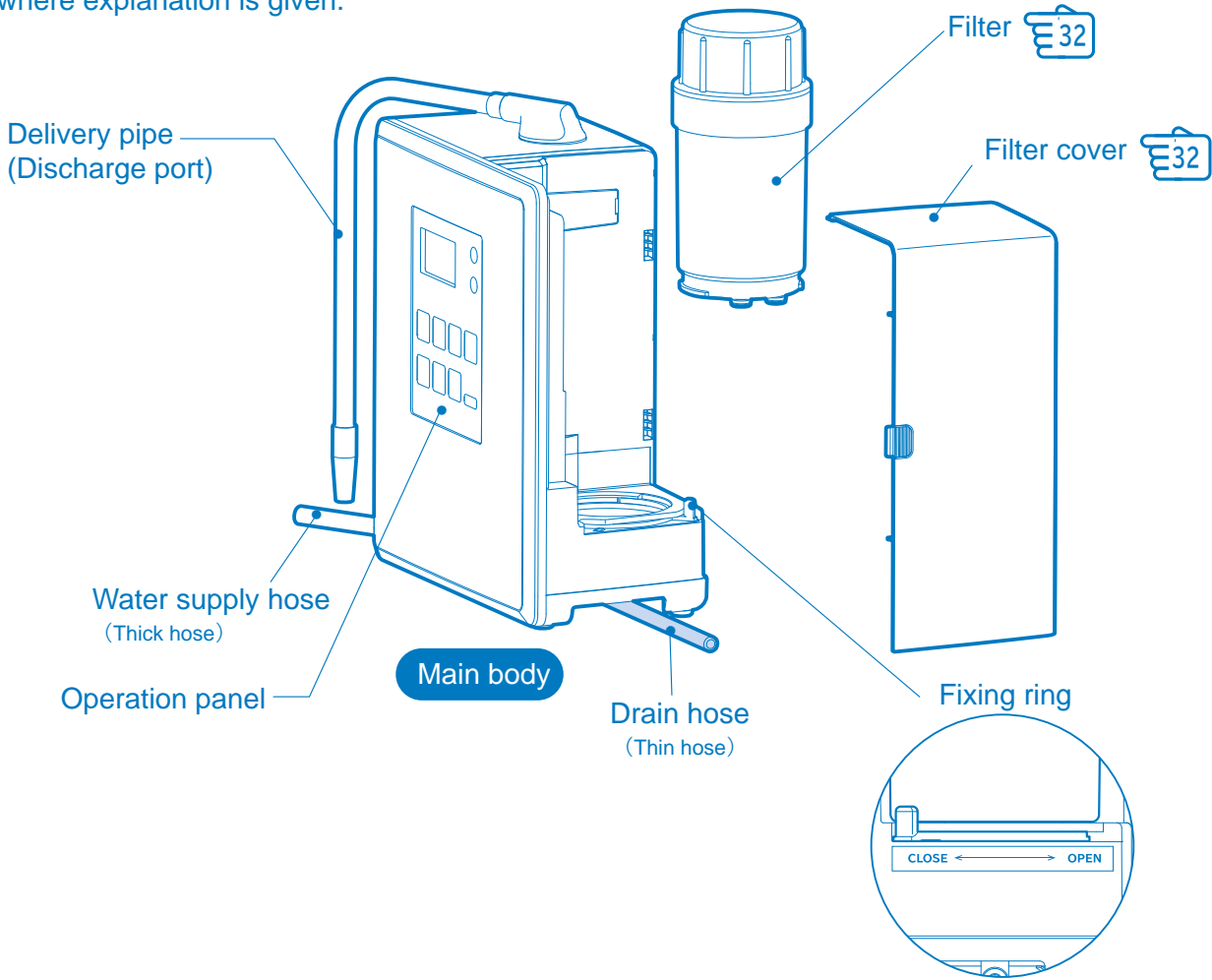

# Name of each part

continued

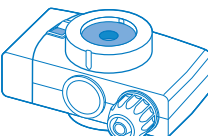
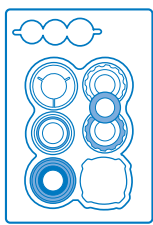
Number in  indicates the page where explanation is given.

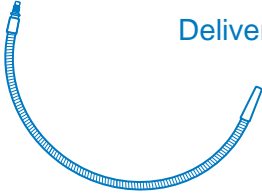
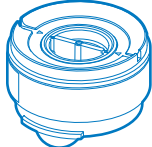

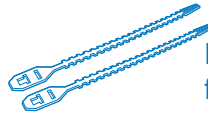
## <Accessories>

	Corporation stop		Accessory for mounting corporation stop		Filter replacement seal 1 sheet
	Delivery pipe		Salt case (with "salt spoon" for measuring salt)		Salt (Sanitized water generation auxiliary) 5g in 1 pack (3 packs included)
	Suction cup (for fixing drain hose)		Hose fixing band (2 pieces)		pH test liquid set pH test liquid pH test color paper Dedicated cup

# Name of each part

## <Operation panel>

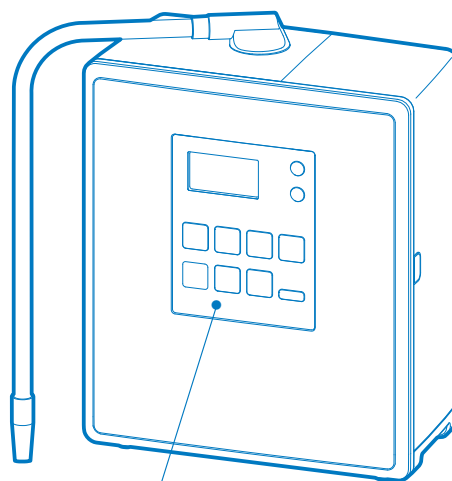

Operation panel

Number in  indicates the page where explanation is given.

### Contents of the LCD monitor



※All contents are never displayed at the same time.

- 生成中** ..... “Generating” mark
- Hiモード** ..... “Hi mode” mark
- H<sub>2</sub>** ..... “Hydrogen plus” mark
- 準備中** ..... “Preparing” mark
- 洗浄中** ..... “Cleaning” mark
- すすぎ** ..... “Rinsing” mark
- 目安表示** ..... Approximately
- L/分** ..... L/min
- まで絞る** ..... Control the flow rate not to exceed the value(L/min) displayed on the LCD monitor

### LCD monitor

The pH value of water coming out from the delivery pipe (displays “--” at “Purify” mode), the dissolved hydrogen concentration and the combined total flow rate of water coming out from the delivery pipe and drainage hose, and the usable passing water amount of the filter are displayed. (The above numerical values are rough standards)

※The pH value, dissolved hydrogen amount of the actual generated water may not be stable, and an error may occur in the passing water amount due to variations in water quality and flow rate.

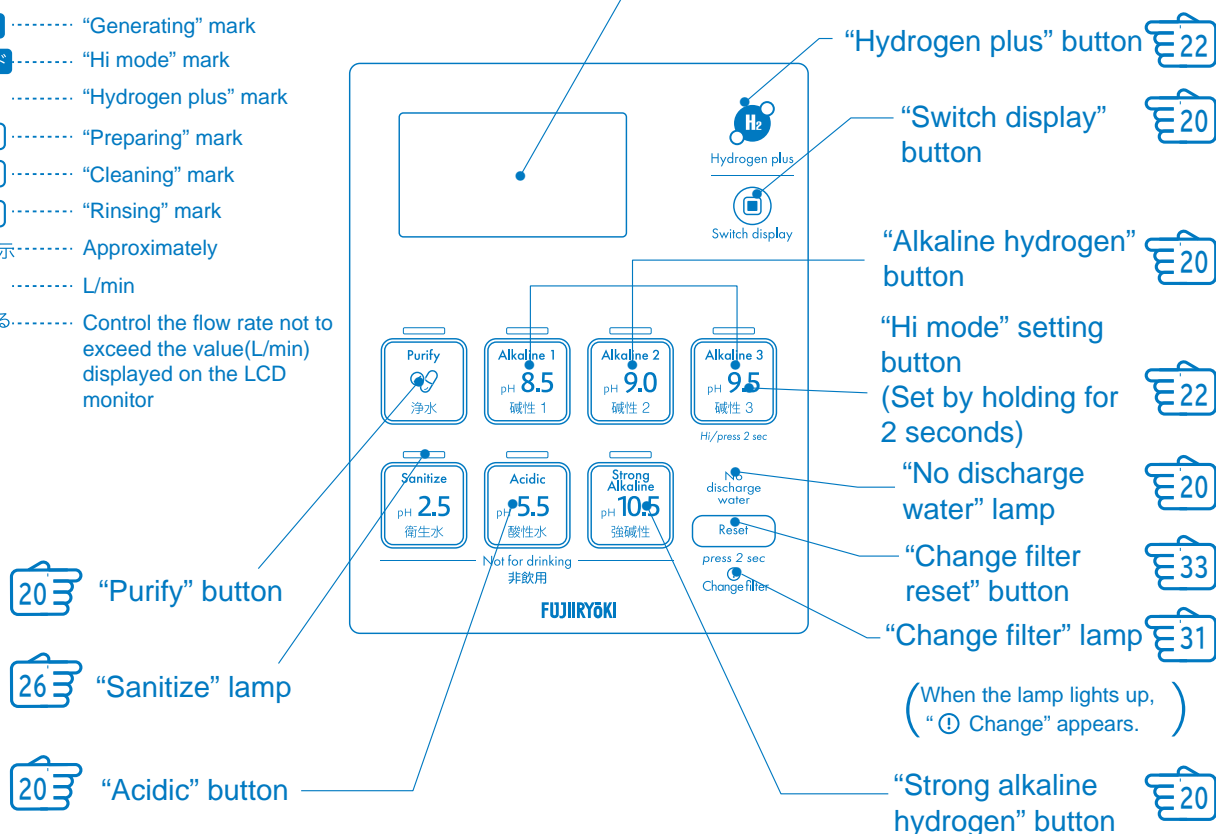

## <Installation completion drawing>

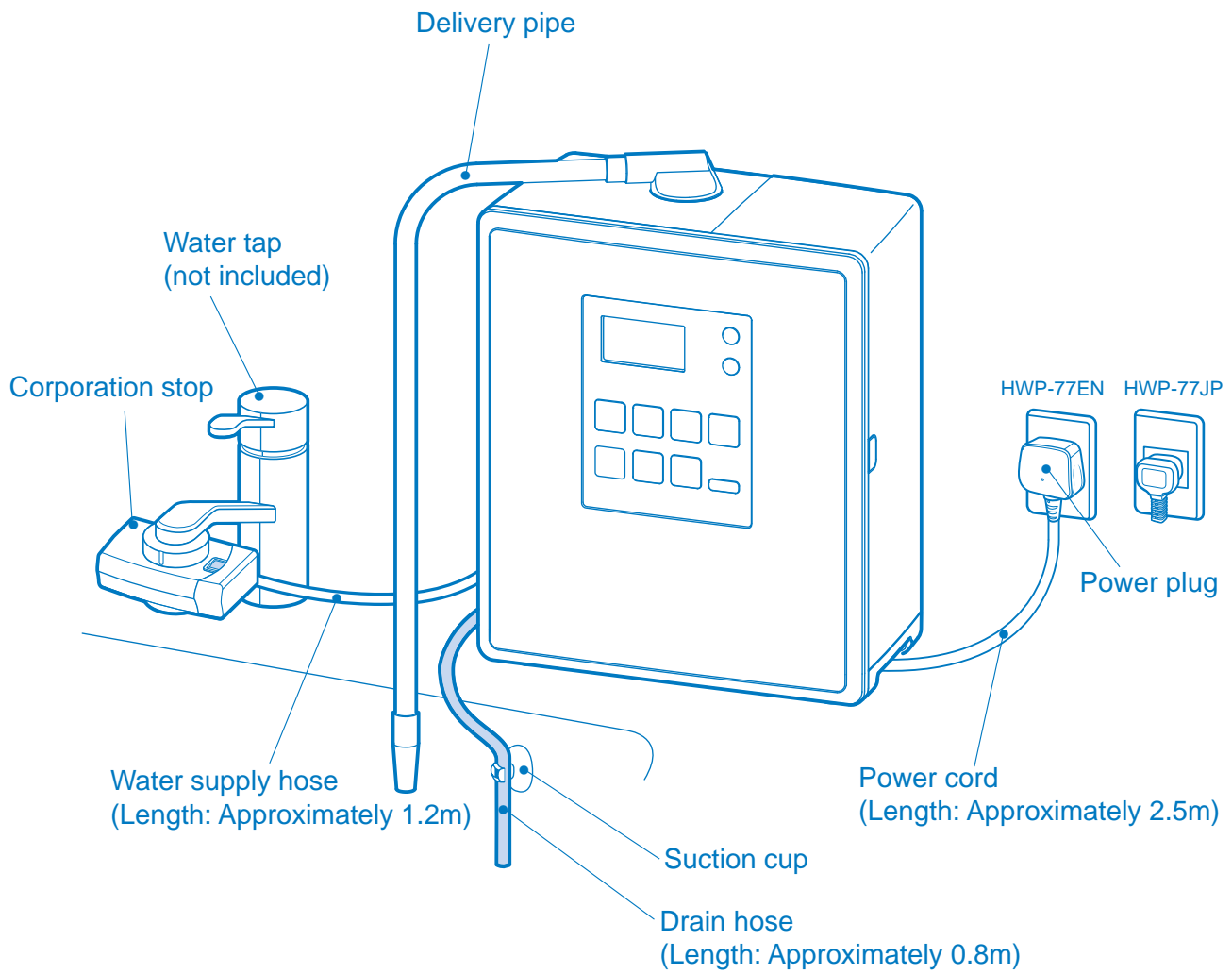

※Install in a stable position around sink.

# Name of each part

## <Corporation stop>

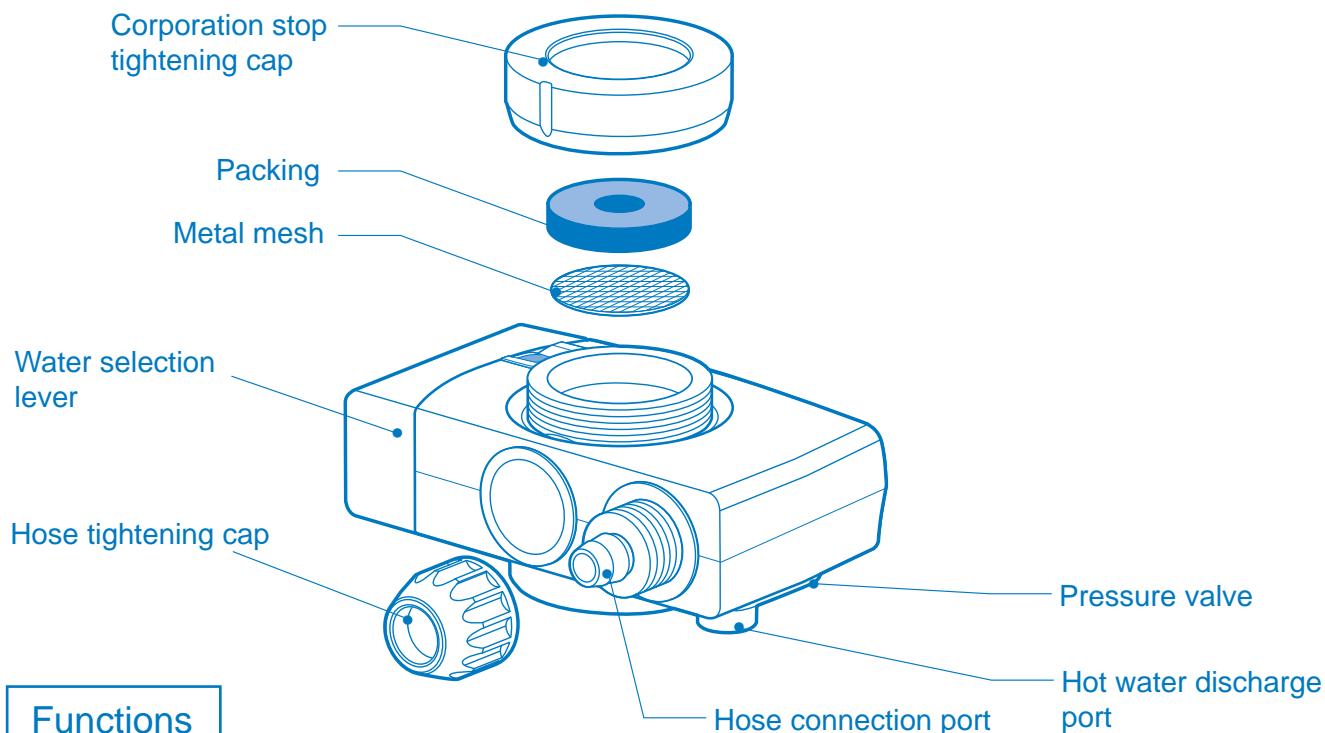

## Functions



- Corporation stop tightening cap .. Fixes corporation stop to water tap.
- Packing ..... Prevents water leak from the connection parts of the corporation stop and water tap.
- Metal mesh ..... When the metal mesh has clogged with contaminants, water quantity decreases. If water quantity of “tap water” and “ionized water and purified water” decreases, or after use for a long time (6 months or longer), remove contaminants which have accumulated in the metal mesh with a toothbrush or a similar object.
- Water selection lever ..... Allows to select from “Ionized water and purified water(Ion),” “Tap water shower( ☼ )” or “Tap water straight(Raw).”
- Pressure valve ..... This valve opens to discharge water when water pressure in the main body is excessively high. (Approximately 500kPa) When water comes out of the pressure valve, choke the cock of the water tap because water pressure is excessively high.
- Hot water discharge port ..... When the lever is set to “Ion” side hot water is discharged if hot water of 50°C or higher flows.
- Hose connection port ..... Connect the water supply hose.
- Hose tightening cap ..... Fixes the water supply hose to the hose connection port.

## ●How to use the water selection lever

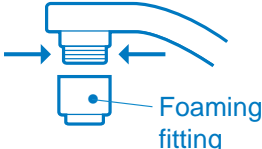
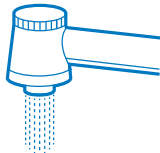
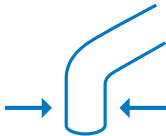
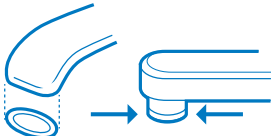

⚠ CAUTION	
 Make sure to observe	Use ionized water and purified water at water temperature of lower than 35°C. (Failure may result.)
	Select accessories for mounting suitable to screw diameter of water tap. (Water leakage may result.)

Corporation stop cannot be mounted to the following water taps.

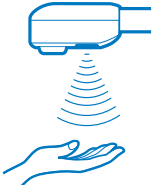
Different screw diameter Not 22mm		With shower	
Water tap diameter 25mm or more		Deformation Special screw diameter	
Tip end is 15mm or less		With sensor	

# How to mount corporation stop

Method of mounting

**Information** Water may leak when installing the corporation stop in a plastic water tap. It is recommended to replace the water tap.

Installation of this part.

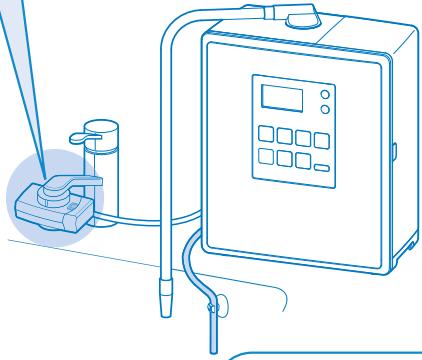

When there is a foaming fitting at the tip end of the water tap

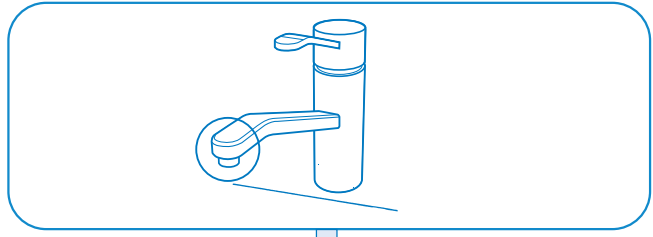

Remove a set of the foaming fittings.

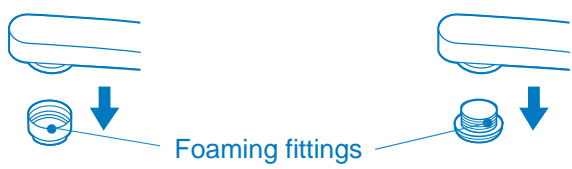

Turn the accessory for outside screw or inside screw with a coin or a similar object, and install the corporation stop tightening cap to the water tap.

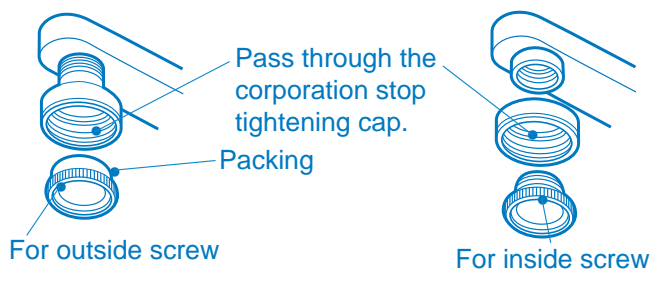

Apply the corporation stop horizontally from below and tighten the corporation stop tightening cap.

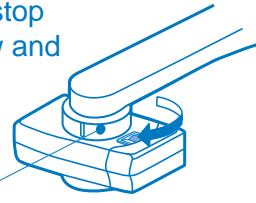

**CAUTION**

Do not use any tools to mount the corporation stop tightening cap. (Breakage may result.)

Corporation stop tightening cap

If there is any bulge at the tip end of the water tap

Use the backing of the corporation stop mounting accessory to measure the diameter of the pipe and select a fixing ring to be used.

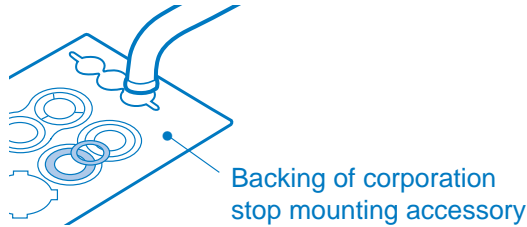

Pass the corporation stop tightening cap through the pipe.

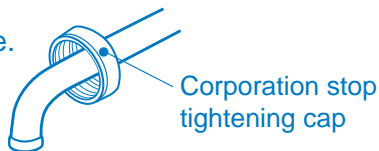

Insert the fixing ring to the end of the pipe.

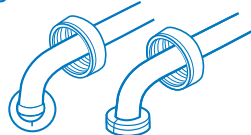

Direct the cutout of the fixing ring toward you so as to easily insert.

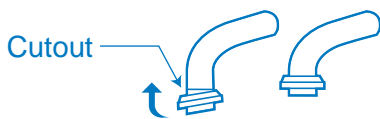

Apply the corporation stop to the water tap horizontally and tighten the corporation stop tightening cap.

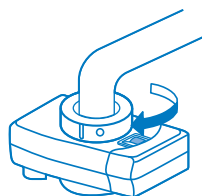

**CAUTION**

Do not use any tools to mount the corporation stop tightening cap. (Breakage may result.)

If the end of the water tap is straight and not stepped

**How to install a screw clamp**

※ No screw clamp is packed together with this product. Place an order with the store where you purchased this product.

(If the corporation stop mounting accessories of 16mm, 17.5mm and 19mm cannot be used)

Remove the screw and pass the fitting through the corporation stop tightening cap.

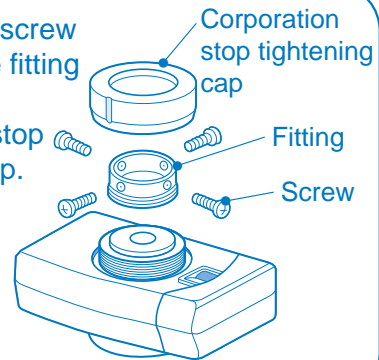

Mount the screw again.

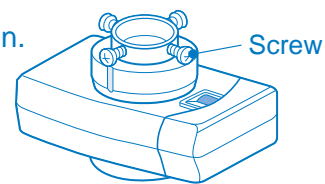

Loosen the screw and set the corporation stop horizontally, and tighten the screw while pressing it against the water tap. Do not excessively tighten the screw. (The water tap may be perforated.)



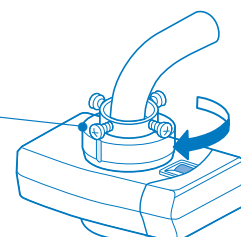

Tighten the corporation stop tightening cap.

Corporation stop tightening cap



# Installation of main body

<b>⚠ CAUTION</b>	
 Make sure to observe	Install so that the main body is horizontal. Do not install in an unstable place such as on a wobbling stand or inclined surface. (The main body may drop or fall off, resulting in injury.)
 Prohibited	Do not install in places described below. (Deformation, discoloration, malfunction or failure may result.) - Place where fire is used, or near object that gets hot (60°C or higher) - On and near microwave oven, electromagnetic range, refrigerator - Place subject to direct sunlight - Place where oil adheres - Outdoors or place subject to wind and rain - Bathroom and place subject to water or steam - Place which may freeze
	Do not extend water outlet with commercially available hose. (Failure may be result.)
	Do not connect other equipment to water supply and drain hoses. (Water leakage or failure may be result.)
	Do not block water outlet and do not bend, twist or crush hose. (Appropriate pH value cannot be obtained, or water leakage or failure may result.)
	Do not install on hot-water supply facility without check valve (backwater valve). (Failure of hot-water supply facility may result.)
	Do not install to water tap dedicated to hot water. (Failure may result.)
Prevent the main body from pressing the power cord, water supply hose, and drain hose. (Water leakage or failure may result.)	

## How to pull out the power cord, water supply hose and drain hose

Determine the direction of right or left for pulling out the power cord, water supply cord and water drain hose according to the installation position.

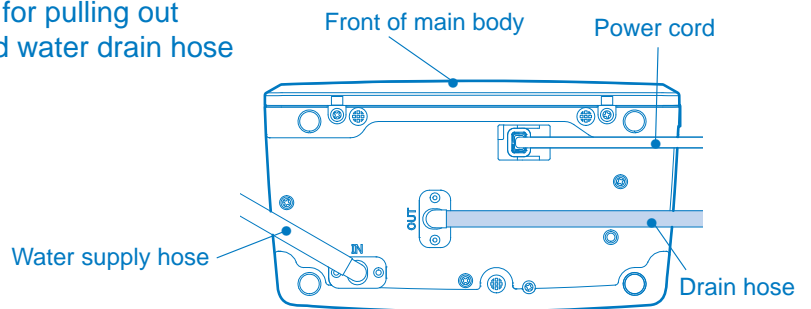

- The water supply hose and drain hose can be routed from the base.

## Installation of the salt case

Place the salt case on the filter.

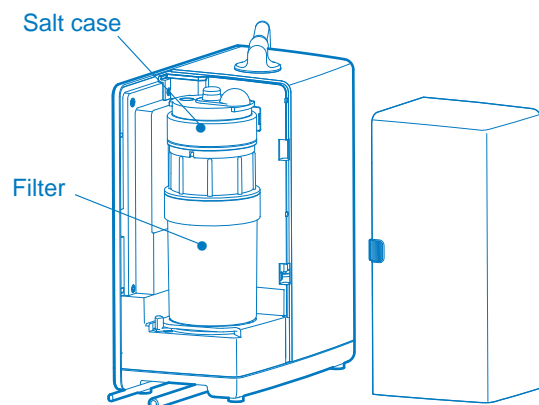



## Installation of the delivery pipe

### ⚠ CAUTION



Prohibited

Do not extend the water outlet with a hose. (Water leakage and failure may result.)

Do not unnecessarily screw in because the inserting part is made of plastic. (Water leakage and failure may result.)

#### Note

- When bending the delivery pipe after installation, hold the root and bend the pipe with your free hand.

#### Installation of this part.

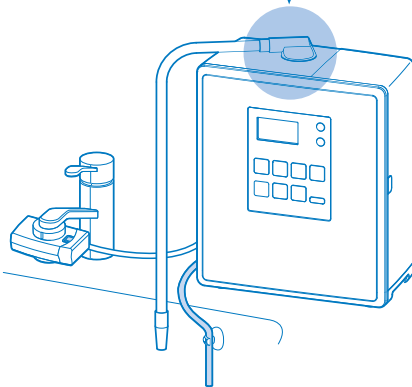

Screw in the delivery pipe to the root.

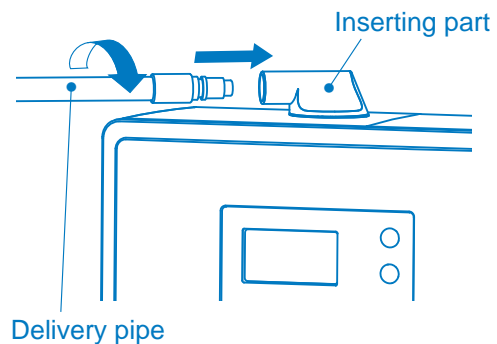

## Installation of the drain hose

#### Note

- The difference in height between the end of the delivery pipe and the end of the drain hose shall be 15cm or more, and less than 40cm. (In order to obtain the appropriate pH value)
- Set the end of the drain hose below the bottom face of the main body.
- If the drain hose is excessively long, cut it for use.
- Prevent the drain hose from being bent.
- Do not extend the drain hose.

Fix the drain hose to a sink with a suction cup.

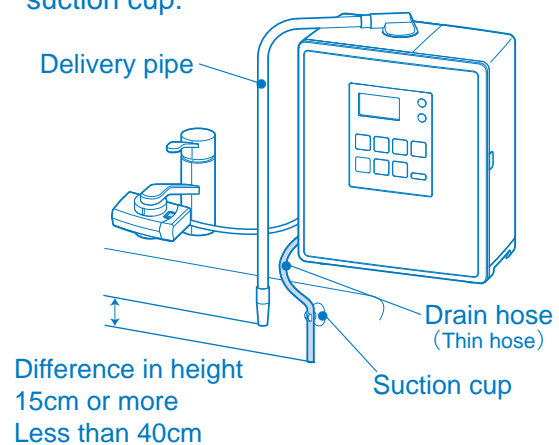

# Installation of main body

## Connection of the water supply hose

### ⚠ CAUTION



Prohibited

Do not bend or twist the water supply hose. (Water leakage may result.)

Do not install to water tap dedicated to hot water. (Failure may result.)

When connecting to a combination tap, do not pass hot water (35°C or higher). (Failure may result.)

#### Note

- When installing the corporation stop to a water tap, set the water supply hose to be flexible so as to allow the water tap to swing to both sides.

#### Installation of this part.

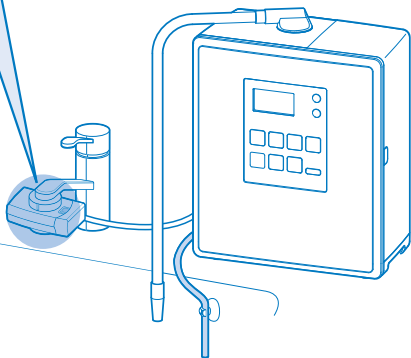

- If the water supply hose is excessively long, it is recommended to cut the hose straight for use.

- 1 Remove the hose tightening cap from the corporation stop and pass it through the water supply hose. (①)

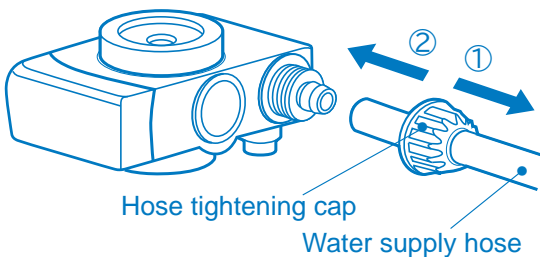

- 3 Firmly tighten the hose tightening cap.
  - Do not use any tools. (Breakage of the corporation stop may result.)

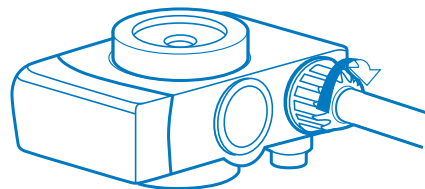

- 2 Insert the water supply hose all the way. (②)

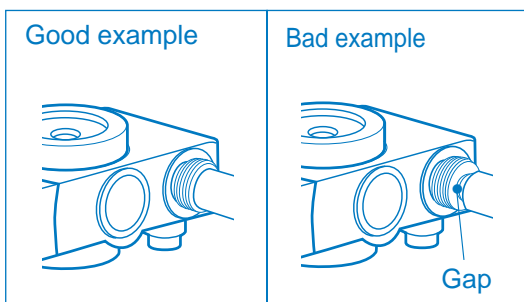

- 4 Fix the water supply hose with the hose fixing band.
  - Do not crush the hose when fixing.

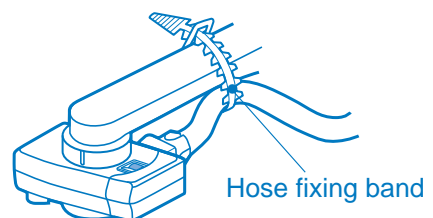

### Make sure to carry out when passing water for the first time after installation.

- Remove the filter cover to confirm that the filter is installed.
- Pass water once before inserting the power plug into the power outlet.

- 1** Set the water selection lever to the “Ion” side and open the cock of tap water.

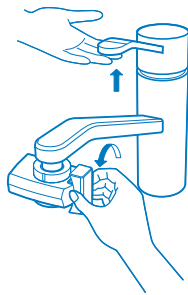

- 2** Pass water until the water becomes transparent.

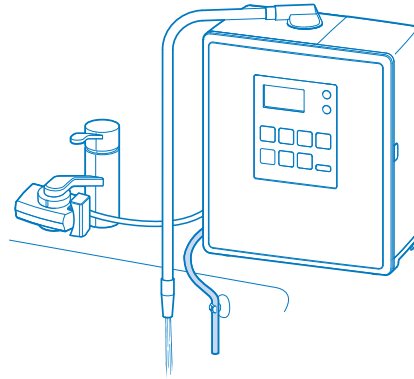

- When water comes out from the pressure valve of the corporation stop, decrease flow rate because water pressure is excessively high.
- When water does not come out, confirm that the water selection lever has been completely switched.
- Switch the water selection lever after stopping water flow. (Failure may result.)

## Using alkaline ionized water, acidic water and purified water continued

### ⚠ 注意



Prohibited

- Do not use while the “Preparing (準備中)” mark on the LCD monitor flashes.
- The “Preparing (準備中)” mark continuously flashes until retained water in the main body is completely flowed.
  - Flashing time depends on use interval or flow rate.

#### Note

- As water becomes turbid immediately after water supply work has been carried out, set the water selection lever to the “Raw” side and wait to use until the water becomes transparent. (Clogging of the filter may result.)
- Do not use with the power plug removed from the power outlet. (Because flow rate for judgment of filter life and number of operating days cannot be counted, there may occur an error in filter replacement period.)

# Using alkaline ionized water, acidic water and purified water

## How to use

- 1** Insert the power plug into the power outlet and press the pH adjustment button to be used.

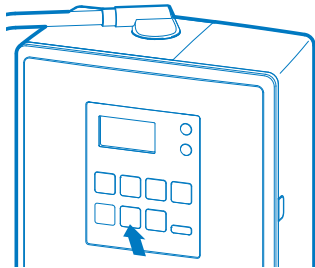

- 2** Set the water selection lever to the "Ion" side and open the water tap.

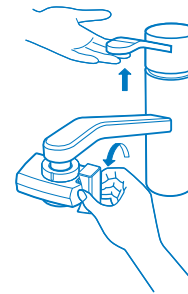

- 3** Use after the indication on the LCD monitor changes from the "Preparing (準備中)" mark to the "Generating (生成中)" mark and the buzzer sounds.

- Water does not come out from the drain hose while the "Purify" mode is used.
- After the "Strong Alkaline" mode or "Acidic" mode is used, and is stopped once and then used again, the water mode automatically returns to the previously used drinkable water mode; Alkaline ionized water 1, 2, 3 or purified water in order to prevent accidental drinking.
- The alarm buzzer keeps sounding when the "Strong Alkaline" mode or "Acidic" mode is used.

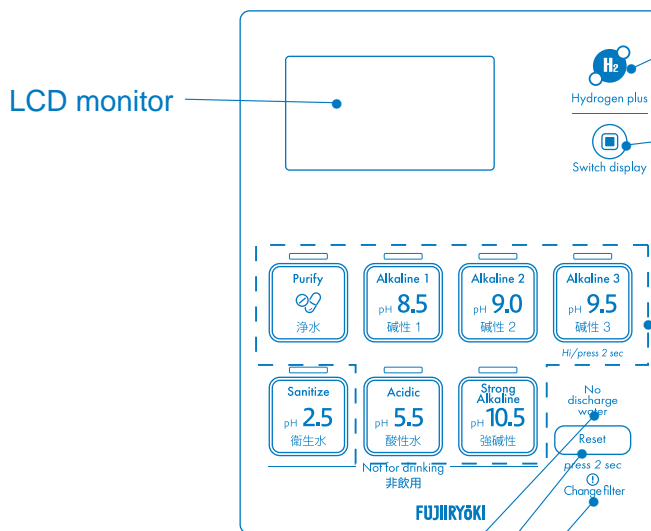

**"Hydrogen plus" button**  
Press this button when setting the hydrogen plus mode.

**"Switch display" button**  
"Dissolved hydrogen concentration → flow rate → remaining filter amount" are displayed every time this button is pressed.

**"pH adjustment" button**  
Press these buttons according to the application.  
The lamp on the pressed button lights up.

"No discharge water" lamp

"Change filter reset" button

"Change filter" lamp

### No discharge water lamp

While this lamp is lit, immediate use is possible because the "Preparing (準備中)" mark does not flash at the time of water passing (no need to discharge water) when continuously using any water quality of alkaline ionized water 1, 2, 3 or purified water that was previously used.

This is convenient for continuously drinking alkaline ionized water or washing rice, etc.

- The "No discharge water lamp" turns off after approximately 30 minutes when the water tap is closed.
- This lamp does not light up when strong alkaline ionized water or acidic water is selected.

pH adjustment button	Application
Strong Alkaline pH 10.5 強鹼性	(Not for drinking)
Alkaline 3 pH 9.5 鹼性 3	For daily use (For drinking)
Alkaline 2 pH 9.0 鹼性 2	For becoming accustomed to drinking (For drinking)
Alkaline 1 pH 8.5 鹼性 1	For first time use (For drinking)
Purify 浄水	(For drinking)
Acidic pH 5.5 酸性水	For face washing (Not for drinking)

※ Refer to "For optimal use" on page 8 for other use applications.

## Alkaline ionized water

Press the “Alkaline 1, 2, 3” or “Strong Alkaline” button to use the “alkaline ionized water” that comes out from the delivery pipe.

## Acidic water

Press the “Acidic” button to use the “acidic water” that comes out from the delivery pipe.

- Water that comes out from the drain hose cannot be used because it is highly alkaline.

### Note

- Acidic water of a pH lower than the indicated pH value may come out if the water flow rate is extremely decreased\* when the “Acidic” is used.  
Although the LCD monitor indicates a standard value of pH5.5, check with a pH measuring liquid.  
※ Extreme water amount means a flow rate of approximately 1.5L/minute at the discharge port or a flow rate which takes approximately 6 seconds to fill one cup as a rough standard.

## Purified water

Press the “Purify” button to use “purified water” coming out from the delivery pipe.

- No water comes out from the water drain hose.

4

Close the water tap and set the water selection lever to the “Raw” side after use.

- When water is stopped, the usable passing water amount serving as a rough standard for filter replacement period is displayed on the LCD monitor.

<Example>

During use

The pH value of the selected mode is displayed.



During standby

Usable passing water amount is displayed.



- The backlight of the LCD monitor is extinguished in approximately one minute after the water tap is closed. All lamps and indications turn off in 30 minutes, and the power off mode is set. The lamps are lit again by pressing the button or passing water.

## Information

- The LCD monitor continuously flashes so as to decrease the flow rate if the flow rate is excessively large. In this case, slowly decrease the flow rate until the indication changes (the set pH is lit).
- When the “Switch display” button is pressed if there is flashing indication to decrease the flow rate, the current flow rate flashes. Flashing changes to lighting when the proper flow rate is obtained by decreasing the flow rate of the tap water.

<Example>



# When pH value of alkaline ionized water is low

Measure the pH value of alkaline ionized water according to the “Measure pH value” on page 28 after installation. When the measured value is lower than the pH value displayed on the LCD monitor (refer to “Information” on page 28):

- Use it as is when the pH value is low due to influence of carbonic acid in the tap water.
  - When the pH value is low due to water quality, set to the “Hydrogen plus” mode or “Hi” mode. The pH value of “Alkaline 1, 2, 3” or “Strong Alkaline” can be increased in the “Hydrogen plus” mode. The pH value of “Alkaline 1, 2, 3” can be increased in the “Hi” mode. Set to “Hi” mode if the pH value does not reach the rough standard range even when “Hydrogen plus” mode is set.
- ※The amount of pH value increase depends on water quality and operating conditions.  
Measure the pH value again after setting.

## Hydrogen plus mode

### [Setting]

Press the “Hydrogen plus” button without passing water in the “Alkaline” and “Strong Alkaline” modes. The “Hydrogen plus” mark lights up on the LCD monitor.

※The “Hydrogen plus” mode can be set in the “Alkaline” and “Strong Alkaline” modes.

※The “Hydrogen plus” button cannot be set in the following cases.

(Beeping sound that indicates a warning.)

- When the “Hi mode” is set - “Purify” mode - “Acidic” mode - While passing water

※When the “Hydrogen plus” mode is set, the “Hydrogen plus” mode is set in the “Alkaline 1, 2, 3” and “Strong Alkaline.”

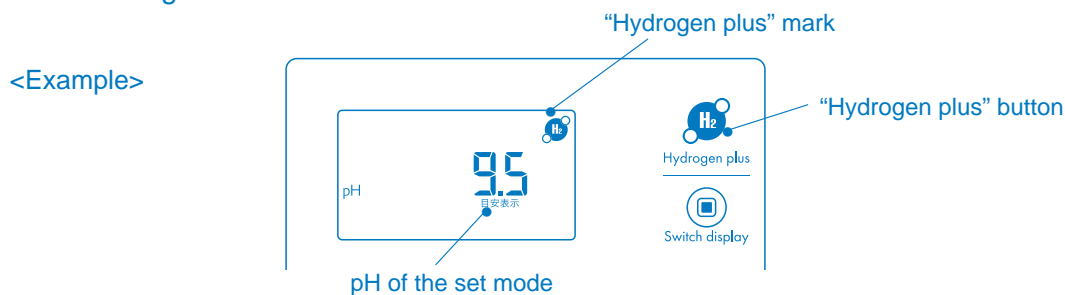

### [Reset]

Press the “Hydrogen plus” button without passing water. The “Hydrogen plus” mark turns off.

## Hi mode

### [Setting]

Hold the “Alkaline 3” button for 2 seconds or longer without passing water.

The “Hi mode(Hiモード)” mark lights up on the LCD monitor. When the “Hi mode” is set, the “Hi mode” is set in the “Alkaline 1, 2, 3.”

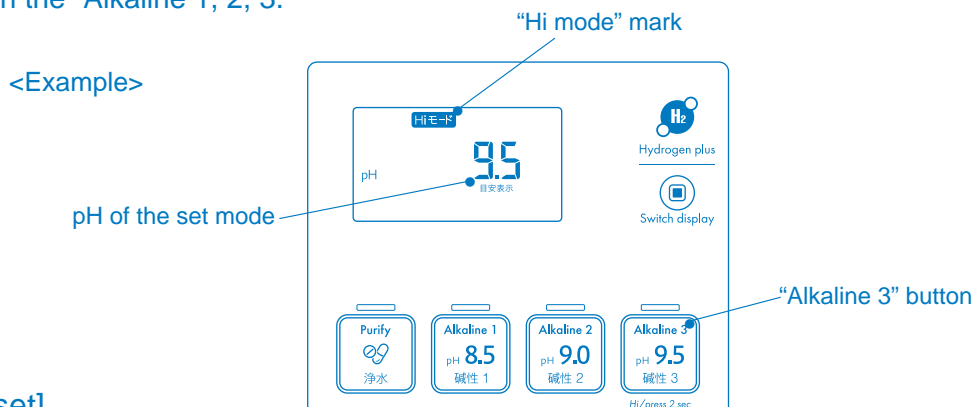

### [Reset]

The Hi mode mark turns off by holding the “Alkaline 3” button for 2 seconds or longer without passing water.

# Switch display

(dissolved hydrogen concentration, flow rate, usable passing water amount)

The screen switches in the order of “dissolved hydrogen concentration → flow rate → remaining filter amount” every time the “Switch display” button is pressed during generation.

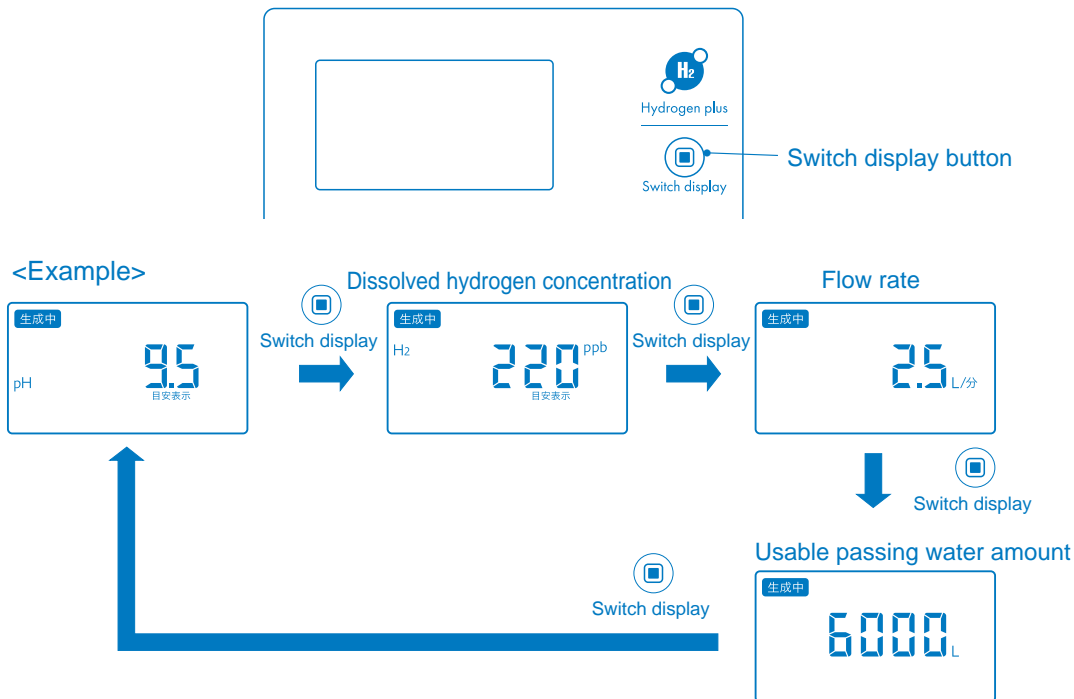

- The pH value and dissolved hydrogen concentration are rough standard indications. They may be different from the actual numerical values depending on the water quality.
- Dissolved hydrogen concentration is displayed when setting “Alkaline1,2,3”, “Strong Alkaline” “Hydrogen plus” and “Hi” mode.

# Confirming filter life (remaining amount)

The usable passing water amount serving as a rough standard for filter replacement and the number of usable days are displayed on the LCD monitor.

- The usable passing water amount is 8,000 L. (Filter capacity)
  - ✧8,000 L at the start of use is decreased in units of 1L (liter) every time water passing is performed and the remaining amount is displayed.
- Usable period is 730 days.
  - (The recommended maximum use period in consideration of hygiene: Approximately 2 years)
  - ✧The number of usable days is displayed together with the usable passing water amount when approximately 2 years have passed since the start of use and when the number of remaining days is 14 days or less.
  - ✧Standby time is also counted and displayed as the number of days, therefore, an error occurs if the power plug is removed.
- Refer to the “Filter replacement” on page 31 for the relationship between the filter replacement lamp and the LCD monitor contents (usable passing water amount and number of usable days).

## Check with automatic display

- When water is stopped, the remaining amount is automatically displayed.

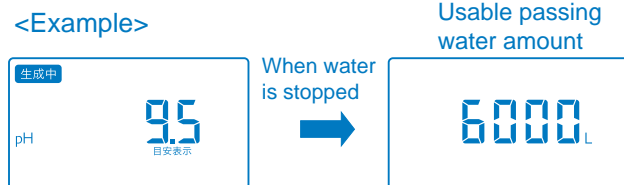

✧If the number of usable days becomes 14 days or less, it is also displayed.

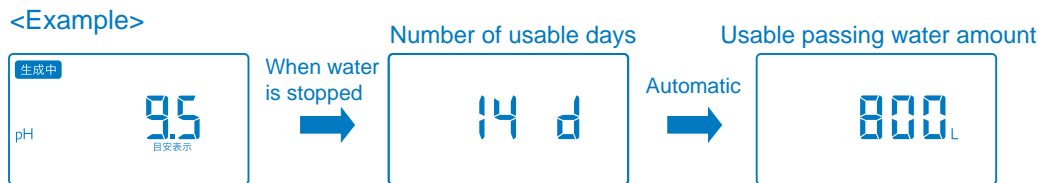

## Check by pressing the Switch display button

- The remaining amount can be displayed by pressing the “Switch display” button.

<Example>

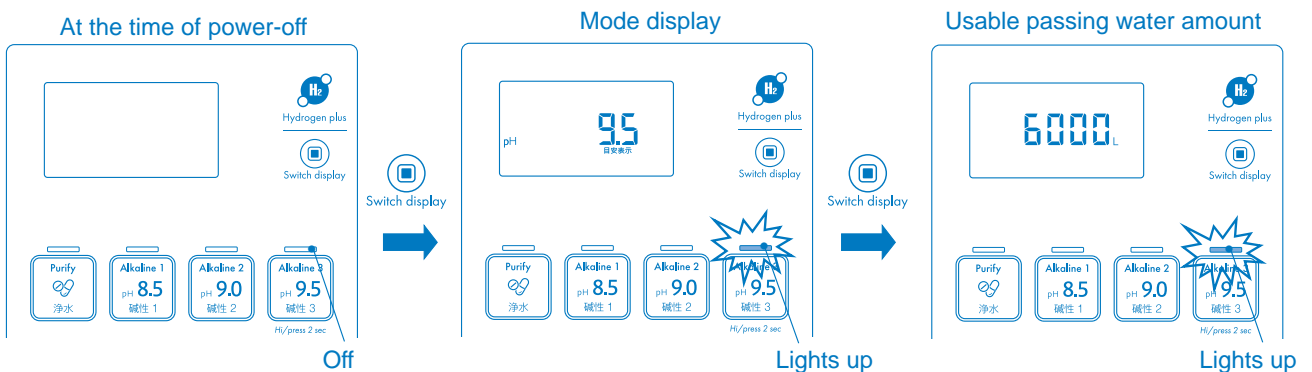

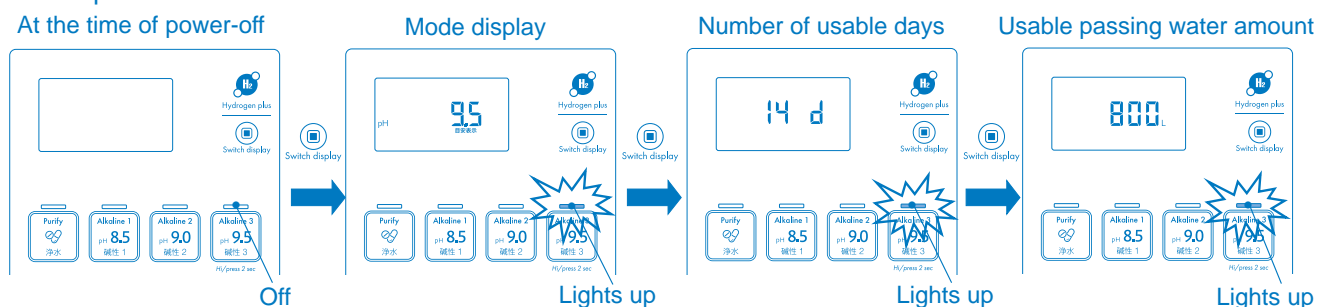

✧If the number of usable days becomes 14 days or less, the number of days is also displayed.

<Example>





## Sanitized water: Cleaning the water passage.

<b>⚠ CAUTION</b>	
 Prohibited	Never drink sanitized water because it is strong acidic water of approximately pH2.5. (Poor physical condition may result.)
	When feeling any abnormality with your body by using sanitized water, immediately stop using and consult with a doctor.
	Do not add any salt other than usable salt in the salt case. (Failure may result.) Refer to the "Usable salt" on page 27 for salt that can be used.
	Do not store sanitized water. (Generated chlorine may result in poor physical condition.)
	Do not soak metallic dishes or rings in sanitized water. (Rust and discoloration may result.)
 Make sure to observe	When generating, using or draining sanitized water, use in a well-ventilated place by turning on a ventilation fan or opening a window because a chlorine odor occurs. (Poor physical condition may result.)
	If sanitized water or water coming from the drainage water hose gets into your eyes, immediately rinse eyes out with a plenty of tap water.
	After generating, using or draining sanitized water in a stainless steel sink, rinse out sink with tap water. (Discoloration of sink may result.)
	When sanitized water splashes on clothing or hair, rinse clothing or hair off with tap water. (Discoloration may result.)

How to use

**1** Confirm that water does not flow. Remove the filter cover to take out the salt case.

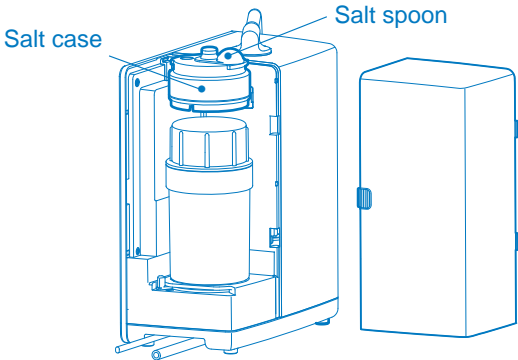

Labels: Salt case, Salt spoon

**2** Remove the salt spoon and turn the screw cap counterclockwise to pull out.

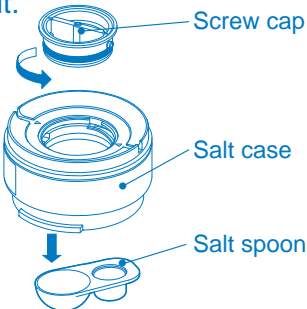

Labels: Screw cap, Salt case, Salt spoon

**3** Add the included salt into the salt case, and turn clockwise until the Δ on the salt cap aligns with the Δ on the salt case to attach. (Insufficient attachment results in water leak.)

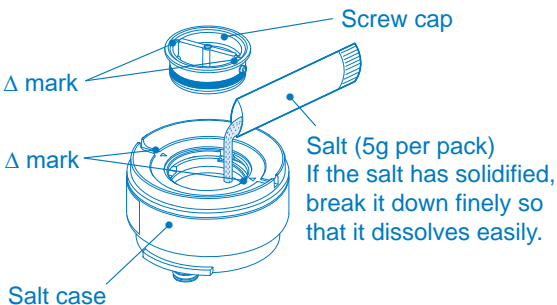

Labels: Screw cap, Δ mark, Salt (5g per pack) If the salt has solidified, break it down finely so that it dissolves easily., Salt case

Add in an amount of included salt that corresponds to the amount of sanitized water to be generated.

- Approximately 5g of salt (Approximately one scoop of the salt spoon) Approximately 1 liter of sanitized water
- Approximately 10g of salt (Approximately two scoops of the salt spoon) Approximately 2 to 3 liters of sanitized water
- Approximately 15g of salt (Approximately three scoops of the salt spoon) Approximately 4 to 5 liters of sanitized water

# Generation of sanitized water

- 4** Turn the fixing ring to the OPEN position to remove the filter.

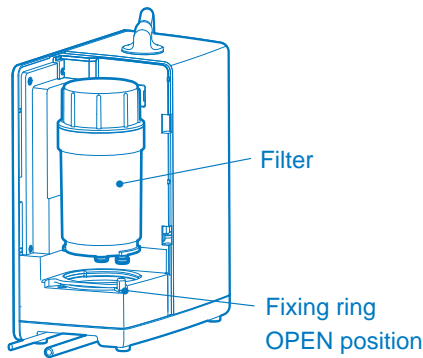

※When the filter is difficult to pull out, hold the main body from above and wiggle it back and forth to pull it out. (Note that water comes out from the bottom of the filter.)

- 5** Attach the salt case to the main body, and turn the fixing ring to the CLOSE position.

(Align the hole on the main body pipe with the pipe of the salt case, and firmly insert into the deep end.)

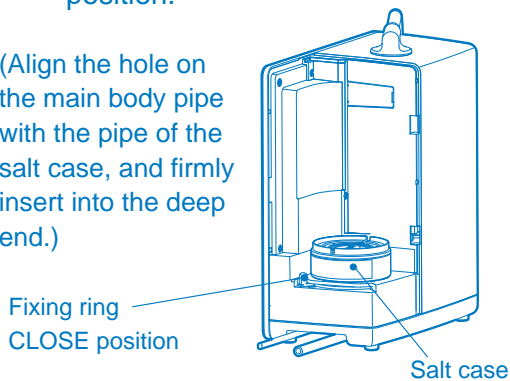

- 6** Confirm that the sanitize lamp is flashing, and attach the filter cover.



- 7** Open the cock of the water tap. The LCD monitor flashes for approximately 3 seconds, and then the “Sanitized water” is generated. The LCD monitor changes to lit during generation.

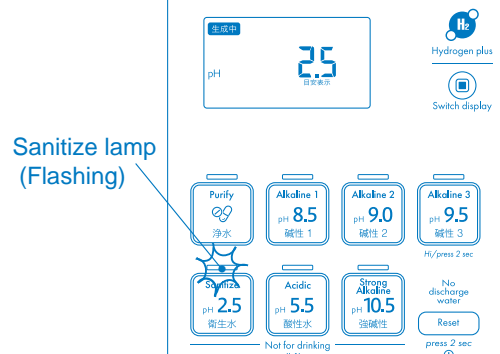

<If the LCD monitor does not change to lit>

- There is no salt in the salt case. Add salt into the case.
- The salt is solidified and has not dissolved. Replace the salt.

- 8** If salt runs out after generation of the “Sanitized water” rinsing is automatically carried out for approximately 30 seconds. Water during rinsing is not sanitized water. Salt remaining in the water passage is flowed out by rinsing. Do not tighten the cock of the water tap until rinsing is completed.

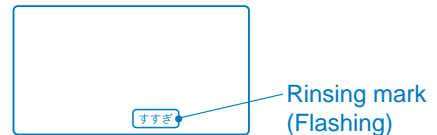

- An alarm sounds during generation of the “Sanitized water” and rinsing.
- The “Alkaline”, “Purify” and “Acidic” mode cannot be used while the sanitize lamp is flashing.

- 9** Close the water tap and then remove the salt case after completion of rinsing.

Remove the filter cover, and turn the fixing ring to the OPEN position to pull out the salt case upward. If water comes out from the salt case, wipe the water off.

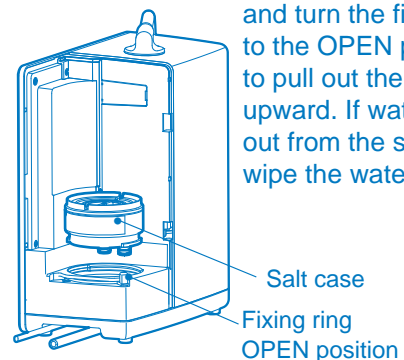

- 10** Align the hole on the main body pipe with the pipe of the filter, and firmly insert into the deep end, then turn the fixing ring to the CLOSE position.

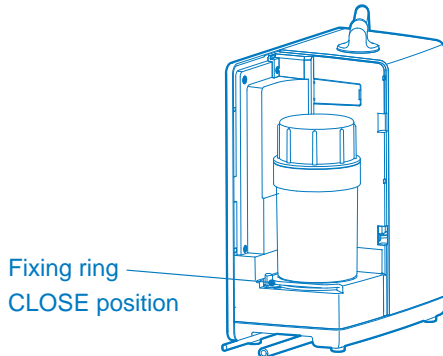

- 11** Attach the salt spoon to the salt case, then place it on the filter, and attach the filter cover.

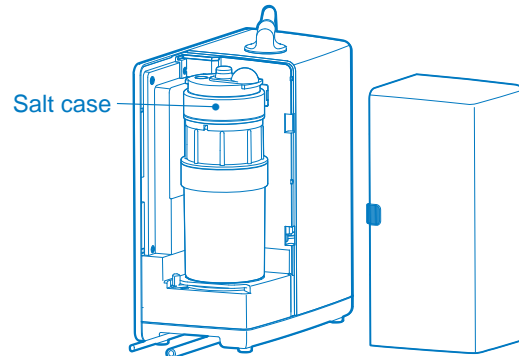

### Usable salt

Sodium chloride or salt consisting of 99% or more sodium chloride can be used in addition to the attached salt.

### Rough standard for the addition amount of salt corresponding to the generated amount of sanitized water.

Use the level difference on the salt case as a rough standard, and add salt (sodium chloride or salt consisting of 99% or more sodium chloride) corresponding to the generated amount of sanitized water. (Refer to the "Generation of sanitized water" [3] on page 25.)

- When using any salt other than the included salt, it is convenient to use the salt spoon (5g).
- If an excessive amount of salt is added, the remaining salt in the salt case solidifies, and sanitized water may not be generated.

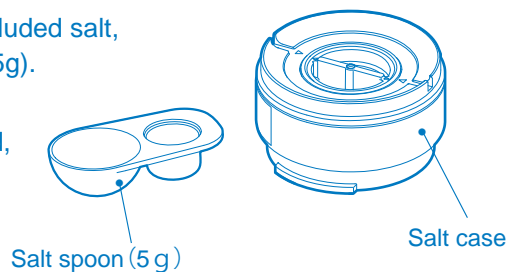

### When salt has solidified

If salt is left in the salt case, the salt solidifies and will not dissolve when sanitized water is generated, and sanitized water may not be generated.

(Even when salt is added to the salt case, the LCD monitor remains flashing and sanitized water cannot be generated.)

Wash out the solidified salt with tap water, and add new salt into the salt case.

## Precautions for use

- When using in areas where water is hard\*, pass acidic water for approximately one minute at the beginning of daily use.  
(Because calcium adheres to discharge port and water channel to cause water to poorly come out.)  
\*Areas where water is hard: Soap foams poorly and white matter (calcium) adheres to kettles and pans.
- Do not pass well water containing salt such as seawater (well water close to the shore).  
※The "Rinsing (すすぎ)" mark on the LCD monitor flashes and alkaline ionized water may not be generated.
- Do not hold the delivery pipe, filter or salt case to lift up the main body. (Breakage may result.)

# Measuring pH value

## ⚠ CAUTION



Prohibited

Do not drink pH test liquid or water containing pH test liquid, or do not put into eyes. (In particular, pay close attention to children.) Poor physical condition may result.  
 - If you accidentally drink pH test liquid, drink a large amount of water and seek medical attention.  
 - If you accidentally get pH liquid into your eyes, sufficiently wash with water and seek medical attention.  
 - Make sure to cover with a lid and store in a cool and dark place away from infants.



Keep fire away

Do not bring pH test liquid close to fire because it contains alcohol. (Fire may result)

- After installation and if not used for a long time (one week or longer as a rough standard), make sure to measure the pH value with the included pH test liquid, and confirm that the Alkaline 3 (pH value of 9.5 as a rough standard) does not exceed pH10 before use. Reset the Hydrogen plus mode at this time. Periodically measure it after that (more frequently than once a month).
- Flow alkaline ionized water for 5 seconds or longer after the LCD monitor changes from “Preparing(準備中)” to “Generating(生成中)”, and take in the included dedicated cup. (In order to measure stable pH)

1

Add alkaline ionized water in the dedicated cup and rinse 2~3 times, and then add it up to the scale.

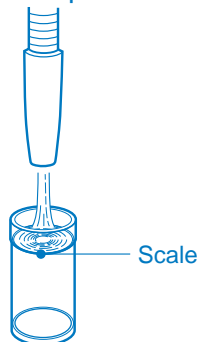

3

Compare the color of the colored water with the color of pH test color paper, and the numerical value of the same color is the pH of the alkaline ionized water.

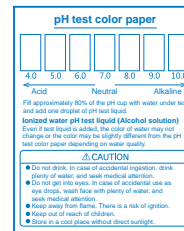

pH test color paper

2

Add one droplet of pH test liquid in the alkali ionized water and slightly shake the cup.

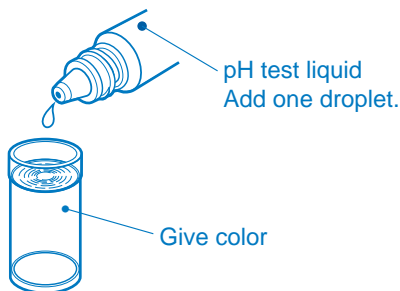

### Information

- When using an underground water source for tap water in some regions, the tap water may contain a large amount of carbonic acid. The selected pH value may not match the pH value of the pH test liquid due to the influence of this carbonic acid. To confirm whether carbonic acid is contained or not, refer to the cause and measures in “Alkaline ionized water does not show blue or dark blue even when tested with pH test liquid” on page 36.
- The pH value of alkaline ionized water may not increase depending on water quality. In this case, take either of the following measures.
  - Set to “Hydrogen plus mode” or “Hi mode.” (Refer to page 22)
- When the pH value is high, take either of the following measures.
  - Change to weakly alkaline mode.
  - Mix purified water for use.
- The pH value of sanitized water cannot be measured.

### Note

- Color of the test water changes as time passes. Compare it with pH test color paper immediately.
- When disposing of raw liquid of pH test liquid, dilute it with water and discharge it to sewage.
- Since pH test liquid and pH test color paper are discolored when exposed to sunlight, store them in a dark place.

# Cleaning inside of the main body

- In order to remove calcium adhering to the electrode plate in the main body and keep the generating function, the electrode plate is automatically cleaned.

When the total water passing amount of the “Alkaline 1, 2, 3” and “Strong Alkaline” exceeds approximately 10 liters.

Tighten the cock of water tap. Or set the Ionized water, purified water, tap water selection lever to the “Raw” side.

After approximately 30 minutes

The electrode plates are automatically cleaned. (for approximately 40 seconds)  
The “Cleaning (洗淨中)” mark is displayed on the LCD monitor during cleaning.  
After cleaning finishes, the “Cleaning (洗淨中)” mark turns off, and the cleaned water comes out from the drain hose.



When water is passed after automatic cleaning ends, generation is started after the cleaned water is discharged.  
※The “Cleaning (洗淨中)” mark and “Preparing (準備中)” mark flash on the LCD monitor and the buzzer sounds (approximately 6 seconds + preparing time) while the cleaned water is discharged.  
Do not use.

## Note

- When water is passed during automatic cleaning, discard the water until the indication on the LCD monitor changes from the “Preparing (準備中)” mark to the “Generating (生成中)” mark.

# Maintenance

## ⚠ CAUTION



Keep dry

Do not splash water on or wash the main body.  
(Electric leakage or electric shock may result.)

Moisten a soft cloth with water or diluted kitchen detergent (neutral) and firmly squeeze it to wipe off contamination on the main body and corporation stop.

### ● Maintenance of corporation stop

If contaminants have accumulated in the metal mesh of the corporation stop, the metal mesh will clog and the water amount will decrease. When the water amount of “Ionized water and purified water,” “tap water shower” or “tap water straight” has decreased or if used for a long time (6 months or longer), disassemble the corporation stop and remove contaminants which have accumulated in the metal mesh and shower part with a toothbrush or the like.

- Be careful not to lose parts when disassembling.
- When assembling, refer to the diagram so as not to confuse the assembly order.

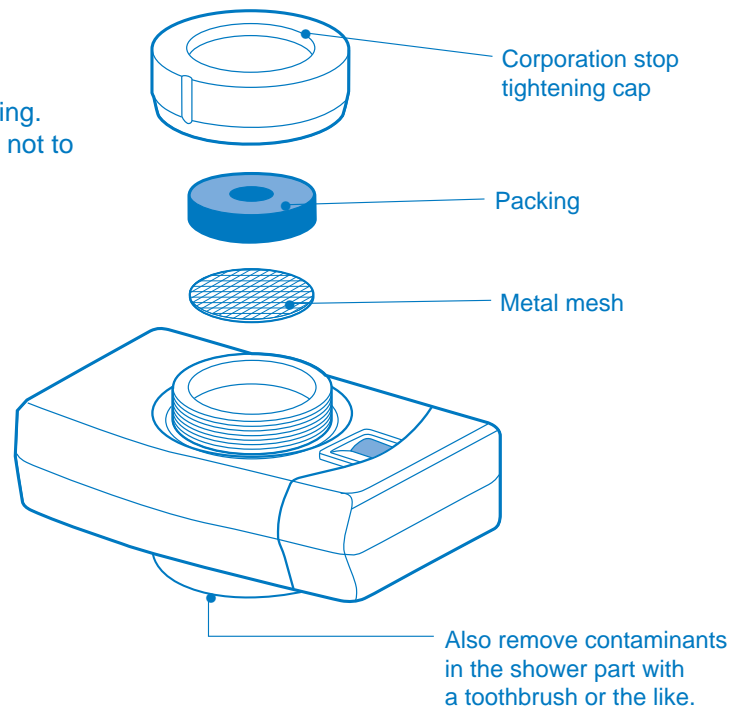

## Anti-freezing

### Note

Drain water in seasons when tap water freezes in cold regions because water retained in the main body and water supply hose may freeze, resulting in breakage of the main body and hoses.

- 1 Set the water selection lever to the “Raw” side.
- 2 Remove the water supply hose from the corporation stop, and place in a location lower than the main body to drain water.
- 3 Thermally insulate the main body with a towel or the like, or place in a warm place.

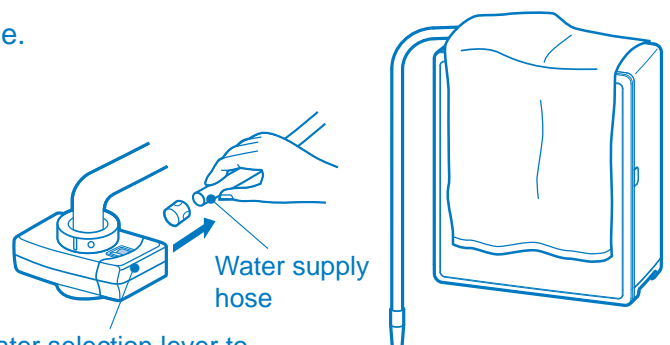

Set the water selection lever to the “Raw” side.

## Filter performance

Product No.	Filtering material	Removable substance
FW-20CM	Hollow fiber film	Fine particles of 0.1 micrometers or larger (such as saprophytic bacteria, red rust)
	Nonwoven fabric	Coarse contaminant
	Granular active carbon	Free residual chlorine, total trihalomethane, soluble lead, CAT (agricultural chemicals), 2-MIB (moldy odor), tetrachloroethylene etc.
	Fibrous active carbon	

## Filter life (Lighting condition of Change filter lamp)

- Usable passing water amount: 8,000L (Filter capacity)
- Usable period: Maximum 730 days (Approximately 2 years, recommended maximum useable period in consideration of hygiene)
- ※The “Change filter” lamp lights up when either of the usable passing water amount or the number of usable days becomes “0” first.
- Rough standard for filter replacement period.
  - If 20 liters are used per day : Approximately 1 year
- ※The rough standard for use depends on your water quality.
  - If you are concerned approximately an odor or if the water amount significantly decreases, consider that it is time to replace the filter even if the filter replacement lamp does not light up.

## Filter replacement period

Filter replacement period is indicated by the LCD monitor and the “Change filter” lamp. (Refer to the following table)

When the “Change filter” lamp lights up, the buzzer sounds after use to inform that replacement is necessary.

- Buzzer sound informing filter replacement period
  - When it is time to replace the filter, the “Change filter” lamp lights up and the buzzer sounds to inform replacement is necessary after each use (for 10 seconds). This buzzer to inform that replacement is necessary can be stopped by holding the screen display button for 2 seconds or longer while the buzzer sounds. When returning to the replacement informing state by the buzzer, remove the power plug from the power outlet once and insert again.
  - ※Pressing the “Change filter reset” button after replacement of the filter returns to the replacement informing state by the buzzer.



	LCD monitor		
	281 liters or more	280 liters or less	0 liters
Usable passing water amount (remaining amount)	281 liters or more	280 liters or less	0 liters
Number of usable days (number of remaining days)	15 days or more (no notification)	Before 14 to 1 day	0 days
Filter replacement lamp	Off	Flashing (*1) It is almost time to replace. Prepare for replacement.	Lit (*2) Please replace the filter.

\*1 The lamp flashes for approximately 30 minutes while passing water and after stopping water.

\*2 The lamp is always lit while water is passed and during standby.

# Filter replacement

## Information

The filter becomes quickly clogged in the following cases.

- Operating time significantly depends on content and turbidity of organic substances.
- Well water may decrease the filter life.
- Total usage amount in a day indicates water amount flowing through the filter, therefore, it is the amount of both of ionized water and drainage water.
- If particles (turbidity and invisible clogging components) and organic substances are contained in water, water amount may significantly decrease.
- If turbid water and red rust water are mixed into the main body due to water service work, the filter will clog and the water amount will decrease regardless of usage time. Replace the filter in this case as well.

Discharge rate may decrease in the following cases.

- Water temperature is low. (Water viscosity increases and it is difficult for water to pass through the filter.)
- Use in a place where water pressure is low (such as the top floor of a building).
- Tap water pressure always changes depending on the local tap water operating state, and water amount may decrease depending on the time of day used.

## When replacing filters

- 1** Close the water tap.  
Remove the filter cover, turn the fixing ring to the OPEN position and pull out the filter upward.  
When the filter is difficult to pull out, hold the main body from above and wiggle it back and forth to pull it out. (Note that water comes out from the bottom of the filter.)

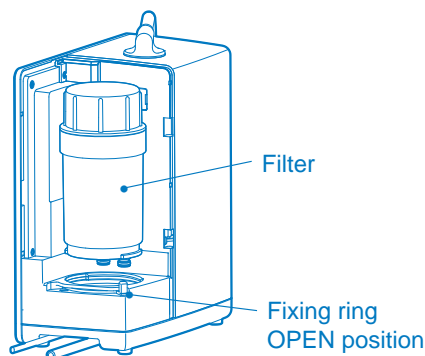

- 2** Attach a new filter, and turn the fixing ring to the CLOSE position.  
Firmly insert it to the deep end.  
Align the filter pipe with the hole on the main body and firmly insert it to the deep end.

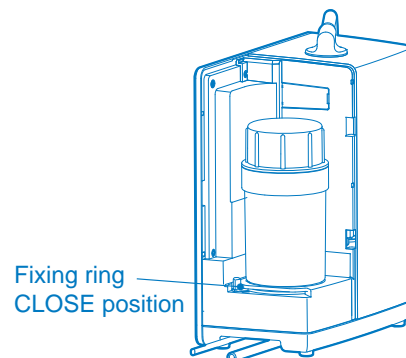

### <Note>

If water comes out from the filter when pulling out the filter and enters the main body, the water will come out from the drainage hole at the bottom of the main body.

Wipe the drained water off.

The product can be used as is.



3

Attach the filter cover, set to the "Purify" mode, and pass water until the water that comes out becomes transparent (for 2~3 minutes). A small amount of black powder from the active carbon in the filter may come out.

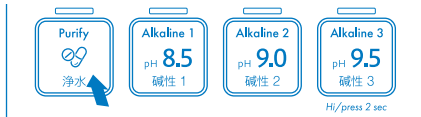



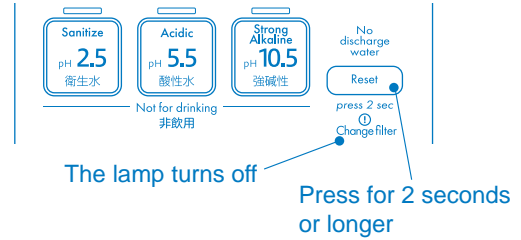

4

Press the change filter reset button for 2 seconds or longer. The buzzer sounds and the change filter lamp turns off.



# When any of the following indications appear

This product has a function to inform the state of this apparatus by the LCD monitor and buzzer. Take corresponding measures when any of the following indications appear on the LCD monitor.

Indication on liquid crystal display	Buzzer sound	Possible cause and measures
	Emits a beeping sound	<ul style="list-style-type: none"> <li>• When the temperature in the main body rises, the protective device operates to stop generation of the “Strong Alkaline,” “Alkaline 1, 2, 3,” “Acidic” and “Sanitize” even though water flows.               <ul style="list-style-type: none"> <li>⇒ Close the water tap, and it is usable after waiting for a while.</li> <li>- The indication and buzzer sound continue for approximately 10 seconds, and then the mode changes to the “Purify” mode.</li> <li>The purified water can be used as it is.</li> </ul> </li> </ul>
	Emits a beeping sound	<ul style="list-style-type: none"> <li>• The water easily carries electricity.               <ul style="list-style-type: none"> <li>⇒ Set to the “Purify” mode, flow water for a while, and then use again.</li> <li>When the machine cannot be restored even after the above measures are taken, please contact the store where you purchased this product.</li> <li>- The indication and buzzer sound continue for approximately 10 seconds, and then the mode changes to the “Purify” mode.</li> <li>The purified water can be used as it is.</li> </ul> </li> </ul>
	Emits a beeping sound	<ul style="list-style-type: none"> <li>• The water is difficult to electrolyze.               <ul style="list-style-type: none"> <li>⇒ Set to the “Hi” mode. When the machine cannot be restored even after the above measures are taken, please contact the store where you purchased this product.</li> <li>- The indication and buzzer sound continue for approximately 10 seconds, and then the mode changes to the “Purify” mode.</li> <li>The purified water can be used as it is.</li> </ul> </li> </ul>
(Example) Alkaline 3  	Emits a beeping sound	<ul style="list-style-type: none"> <li>• “Strong Alkaline,” “Alkaline 1, 2, 3,” “Acidic” or “Sanitize” is continuously generated for the following time, the timer in the main body operates to stop generation.               <ul style="list-style-type: none"> <li>- The indication and buzzer sound continue for approximately 10 seconds, and then the mode changes to the “Purify” mode.</li> <li>- Strong Alkaline ----- Approximately 10 minutes</li> <li>- Alkaline 1, 2, 3 ----- Approximately 30 minutes</li> <li>- Acidic ----- Approximately 10 minutes</li> <li>- Sanitize ----- Maximum approximately 5 minutes</li> <li>- Hi mode (Alkaline 1, 2, 3) ---- Approximately 20 minutes</li> <li>- Hydrogen plus mode ----- Approximately 20 minutes (approximately 10 minutes for Strong Alkaline)</li> </ul> </li> <li>⇒ Use the “Strong Alkaline,” “Alkaline 1, 2, 3,” “Acidic” or “Sanitize” after waiting for approximately 40 minutes. The purified water can be used as is.</li> </ul>

	In such a case	Possible cause and measure	Reference page
Indication	Nothing is indicated (lit).	<ul style="list-style-type: none"> <li>● Is the power plug removed from the power outlet? ⇒ Securely insert the power plug all the way.</li> </ul>	11
		<ul style="list-style-type: none"> <li>● The lamps automatically go off when not in use because of the power off mode. ⇒ This is not a failure. Can be used when water passes again. ※All lamps go off when not used for 30 minutes or longer after water is stopped.</li> </ul>	21
	Nothing is indicated on the LCD monitor while water passes.	<ul style="list-style-type: none"> <li>● Is the filter clogged? ⇒ Time when the filter is clogged significantly depends on water quality of tap water (such as turbidity, iron rust). Replace the filter.</li> </ul>	31 } 33
		<ul style="list-style-type: none"> <li>● Has the water pressure decreased? ⇒ Wait until water pressure has recovered.</li> </ul>	—
		<ul style="list-style-type: none"> <li>● Is the water supply hose bent? ⇒ Correct the bend.</li> </ul>	—
		<ul style="list-style-type: none"> <li>● Is the corporation stop clogged? ⇒ Remove contaminants adhered to the filter in the corporation stop.</li> </ul>	30
	Change filter lamp remains lit.	<ul style="list-style-type: none"> <li>● Have you forgotten to press the change filter reset button? ⇒ When replacing the filter, press the change filter reset button for 2 seconds or longer.</li> </ul>	33
Change filter lamp lights up quickly.	<ul style="list-style-type: none"> <li>● Check usable passing water amount of the filter on the LCD monitor. ⇒ If a large amount of water is used daily, the lamp will light up quickly.</li> </ul>	24	
“- - -” and “Rinsing (すすぎ)” indications on the liquid crystal display flash.	<ul style="list-style-type: none"> <li>● The water easily carries electricity, or the water is difficult to electrolyze. ⇒ Set to the “Purify” mode and flow water for a while, and then use.</li> </ul>	27	

# When failure is suspected

	In such a case	Possible cause and measure	Reference page
Generated water	“Alkaline ionized water” does not show blue or dark blue even when tested with pH test liquid.	<ul style="list-style-type: none"> <li>This is the influence of carbonic acid in tap water. Electrolysis was performed. Check for carbonic acid by the following methods.                             <ol style="list-style-type: none"> <li>Add alkaline ionized water of pH 9.0 to a cup.</li> <li>Add two droplets of pH test liquid to the dedicated cup.</li> <li>Add the alkaline ionized water which was taken in the cup up to the scale on the dedicated cup. If the water becomes blue or dark blue and then immediately discolors to green or yellow, it contains carbonic acid.</li> </ol> </li> </ul>  <p>(1) Add alkaline ionized water to a cup. (2) Add 2 droplets of pH test liquid to the dedicated cup. (3) Add the alkaline ionized water to the dedicated cup.</p>	22 28
	pH test liquid dose not show orange with “Sanitized water”.	<ul style="list-style-type: none"> <li>This is the influence of chlorine contained in sanitized water. ⇒ If there is a chlorine odor, this means that sanitized water has been generated.</li> </ul>	25 28
	“Sanitized water” cannot be generated.	<ul style="list-style-type: none"> <li>Has salt solidified in the salt case? ⇒ Wash out the solidified salt and add new salt.</li> </ul>	27
	Amount of generated water and purified water has decreased.	<ul style="list-style-type: none"> <li>Is the filter clogged? ⇒ Clogging timing may greatly depend on water quality (turbidity, iron rust) of tap water. Replace the filter.</li> </ul>	31 33
		<ul style="list-style-type: none"> <li>Is the corporation stop clogged? ⇒ Remove contaminants adhered to the metal mesh in the corporation stop.</li> </ul>	30
	Abnormal odor occurs.	<ul style="list-style-type: none"> <li>Filter life has expired. ⇒ Replace the filter.</li> </ul>	31 33
		<ul style="list-style-type: none"> <li>Is the water used under the “Preparing(準備中)” mark is displayed? ⇒ Use the water after the “Generating(生成中)” mark is displayed and lit.</li> </ul>	20
	White floating matter appears.	<ul style="list-style-type: none"> <li>This is a solid created by a calcium reaction. ⇒ It is not harmful if it is ingested.</li> </ul>	—
	Red water (red rust, etc., mixed water) comes out.	<ul style="list-style-type: none"> <li>Rust from the water pipe or turbidity after water supply work is coming out. (Do not drink.) ⇒ Set the water selection lever to the “Raw” side, and flow water until red water does not come out.</li> </ul>	—
	When “alkaline ionized water” is received by a cup, glittery floating matter can be seen or dark brown or black precipitates and floating matter can be seen.	<ul style="list-style-type: none"> <li>Because of high pH value, components (mainly mineral) which are dissolved in water become hydroxide. (It is not harmful if it is ingested.) ⇒ Decrease the pH value to use.</li> </ul>	20

	In such a case	Possible cause and measure	Reference page
When generated water is used	Surface of an aluminum kettle or pan is blackened.	<ul style="list-style-type: none"> <li>When alkaline water is filled and heated, the surface is oxidized and blackened. (It is not harmful if it is ingested.) ⇒ Use an alumite treated product or a non-aluminum product.</li> </ul>	—
	White matter adheres to a kettle, pan or pot.	<ul style="list-style-type: none"> <li>Calcium which was dissolved in water is crystalized by heating. (It is not harmful if it is ingested.) ⇒ It becomes clear when soaked in vinegar diluted with hot water.</li> </ul>	—
	Hot water becomes cloudy.	<ul style="list-style-type: none"> <li>Because of high pH value, calcium which was dissolved in water is crystalized by heating. (It is not harmful if it is ingested.) ⇒ Decrease pH value to use.</li> </ul>	20
	When rice is steamed with “alkaline ionized water” and kept warm, it becomes yellow.	<ul style="list-style-type: none"> <li>Sugar and amino acids in rice react due to heat. (It is not harmful) ⇒ Decrease pH value to use.</li> </ul>	20
	When rice is steamed with “alkaline ionized water,” it is softened.	<ul style="list-style-type: none"> <li>Rice starch is easily loosened by alkaline, and rice may be steamed softly. ⇒ Decrease pH value or use purified water.</li> </ul>	20
	Black matter adheres inside of the drainage hose.	<ul style="list-style-type: none"> <li>Occurs due to adhesion of fungus in the air. ⇒ It is harmless, however, clean with a neutral detergent or replace with a new drain hose.</li> </ul>	—
When sanitized water is used	Chlorine odor occurs from “sanitized water.”	<ul style="list-style-type: none"> <li>It is the odor of “sanitized water” generated for cleaning. It is not a failure. ⇒ Chlorine odor may cause poor physical condition such as feeling ill, therefore, ventilate sufficiently.</li> </ul>	25 } 27
Other	When starting to pass water, the buzzer sounds.	<ul style="list-style-type: none"> <li>This is an alarm sound not for drinking water (automatic cleaning, sanitized water, strong alkaline water, acidic water).</li> </ul>	29
	Water comes out from the bottom of the product body.	<ul style="list-style-type: none"> <li>There is a hole at the bottom of the main body to drain spilled water if water enters the product or the filter is replaced. ⇒ Wipe up the spilled water. The product can be used as it is.</li> </ul>	—
	“Click” sound is made from the main body.	<ul style="list-style-type: none"> <li>This is an operating sound of parts after automatic cleaning in order to keep performance of this product. This does not indicate an abnormality.</li> </ul>	29

● If the product does not return to normal even after the above measures are taken, failure may occur, therefore, do not repair on your own and contact the store where you purchased this product.

● When not using for a long time, dry after cleaning and keep in a place with as little moisture as possible.

# Specifications

Product No.		HWP-77EN. HWP-77JP
Rating		AC110-240V 50-60Hz 220W
Water supply method		Discharge water tap corporation stop
Water supply connection		Lever selection
Structure		Water purifier (FW-20CM) main body built-in type
Power consumption		Approximately 220W (Standby: Approximately 0.5W)
Main body	Weight	Approximately 4.1kg (When filled with water: Approximately 5.1kg)
	Dimensions	255mm (width) ×142mm (depth) ×324mm (height)
Operable water temperature for passing water in main body		Lower than 35°C (Corporation stop, Lower than 60°C)
Operable water pressure (dynamic water pressure) for passing water in main body		70kPa~500kPa
Operable water pipe pressure (hydrostatic pressure)		70kPa~750kPa
Electrolysis generation water amount	Rated water amount	2.5L / min. (Water pressure 100kPa, when 20°C)
	Discharge port water amount	2.38L / min. (Water pressure 100kPa, when 20°C)
	Drainage port water amount	0.12L / min. (Water pressure 100kPa, when 20°C)
	Maximum discharge port water amount	5.5L / min. (Water pressure 350kPa, when 20°C)
Continuously operable time		Alkaline ionized water: Approximately 30 minutes (Note 1) Acidic water: Approximately 10 minutes (Note 1) Strong alkaline ionized water: Approximately 10 minutes (Note 1) Sanitized water: Max. 5 minutes (when 15g of salt is put in)
Filter capacity	8,000L (Note 2)	Free residual chlorine
		Turbidity (Note 4)
		Total trihalomethane
		Soluble lead
		CAT (Agricultural chemicals)
		2-MIB (mold odor)
		Tetrachloroethylene
		Trichloroethylene
		Chloroform
		Bromodichloromethane
		Dibromochloromethane
		Bromoform
	8,000L (Note 3)	Iron (particulate iron)
		Aluminum (neutral)
		Geosmin
		Anionic surfactant
		Phenols
		Carbon tetrachloride
		Benzene
cis, trans 1,2-Dichloroethylene		
Filtering flow rate	2.5L / min.	
Rough standard for replacement	FW-20CM : Approximately 1 year (if 20L is used per day) (Note 5)	
Length of power cord		2.5m
Power protection unit		Fuse (5A)

(Note 1) It may be shorter depending on the water quality, discharge amount, and usage environment.

(Note 2) Value of the removal rate 80% in JIS S 3201 test.

(Note 3) Values of Japan Water Purifier Association's voluntary standard 8 substances are test results with a removal rate of 80% according to the JWPAS B standard.

Values of iron (particulate iron) and aluminum (neutral) do not specify a filtering capacity.

(Note 4) Value of the filter flow rate 50% in JIS S 3201 test.

(Note 5) This is a case where 20 liters are used per day. If the quantity consumed per day is larger, the replacement timing will be sooner. It may be even shorter depending on the quantity consumed, water quality, etc.



# MEMO

---









A series of horizontal dashed lines for writing.

# 为了安全使用，请务必遵守

- 这里提示注意事项，是为了能让您安全使用本产品，以防您与他人受到危害与损伤。
- 注意事项如下区分。  
都是有关安全重要内容，请务必遵守。

 <b>警告</b>	错误使用时，其危害程度可能会造成使用者死亡或重伤。
 <b>注意</b>	错误使用时，其危害程度可能会造成使用者受伤，或物品损害。









## <图示>

	<p>⊘ 图标表示“禁止”（不能做）。</p> <p> “禁止分解”       “禁止在饮水处使用”</p> <p> “禁止沾水”       “禁止使用湿手触碰”       “禁止烟火”</p>
	<p>● 图标表示“强制”（必须做）。</p> <p> “一般行为”</p> <p> “电源插头从插座上拔出”</p>

- 阅读后，请将说明书安放在随时可以找到位置以便随时阅读。



## ⚠ 警告

 禁止	<p>请不要使用饮用水以外的水。（会造成身体损伤）</p>
	<p>严禁使用交流电110-240V以外的电源。 （会造成火灾，触电）</p>
	<p>请勿使电源接线，电源插头受损。 请勿·用形钉等固定 ·损坏 ·加工 ·强行弯曲 ·拧 ·拉扯 ·靠近发热器械 ·压在重物之下 ·捆扎 ·夹入物与物之间等。（在受损后使用的话，会造成触电，短路，火灾） ※把电源插头从插座上拔出时，请勿拉扯接线，请用手拿电源插头然后拔出。 ※电源接线和电源插头的修理，请务必通过购买的商店申请维修。</p>
	<p>电源线及插头受损或松插座偏松动时停止使用。 （会造成触电，短路，火灾）</p>
 请务必遵守	<p>不小心将主机掉入水中时，请马上把电源插头从插座上拔出，把主机从水中拿出。（会造成触电） ※请务必前往购买的商店，申请维修。</p>
	<p>请将电源插头上覆盖的灰尘去掉。 （如果电源插头上堆积了灰尘，由于湿气等原因，会导致绝缘不好，造成火灾） ※将电源插头从插座中拔出，用干布擦去灰尘。</p>
	<p>电源插头牢固插入插座。 （未插紧的话，会由于触电或发热产生火灾）</p>
 拔出电源插头	<p>维护时，请务必先将电源插头从插座上拔出。（会造成触电）</p>
 禁止沾水	<p>请勿水洗或用水浇主机。（会造成漏电，触电）</p>
 禁止在饮水处使用	<p>请勿在浴室等湿气重的地方使用。（会造成漏电，触电）</p>
 禁止使用湿手触碰	<p>请勿湿手，插电源线等动作。（会造成触电）</p>
 禁止分解	<p>绝对不要改装，也不可自行拆卸，修理。（会造成火灾，触电） ※如需修理，请前往购买的商店申请。</p>

# 为了安全使用，请务必遵守

## ⚠ 注意



请务必遵守

以下人士在饮用碱性离子水前，请先咨询医生。

- 患病者，身体虚弱者或感觉身体有异样者。
- 正在接受医生治疗者，尤其肾脏有疾病者。

饮用碱性离子水后，感觉身体异样，请停止使用并咨询医生。

初次饮用者，请设定碱性离子水1（pH值约8.5），每次饮用少量（1~2杯），习惯碱性离子水后，根据身体情况可提升pH值和饮用量。

- 饮用或使用pH值过高的碱性离子水，可能会造成身体损伤。

以下人士在使用酸性水前，请先咨询医生。

- 敏感肌肤者
- 有过敏性体质者

使用酸性水，感到肌肤产生异样时，请立刻停止饮用并咨询医生。

碱性离子水，净水，酸性水生成后，请立刻使用。

如需保存时，请放入干净的密闭容器中，放入冰箱，2天内使用。

- 由于碱性离子水和净水中的杀菌剂（石灰等）已被去除，容易繁殖一般细菌，如果饮用或使用长时间存放水，会造成身体损伤。

开始使用时，请先将主机内部的积水排完再使用。

- 每天开始使用时，在液晶“准备中（準備中）”的显示至熄灭（约1.0L）通水后再使用。
- 2天以上未使用时，即使液晶“准备中（準備中）”的显示熄灭，也请先通水2分钟以上再使用。



禁止

患有肾疾（肾功能衰竭，钾排泄障碍等）者，请勿饮用碱性离子水。

请勿用碱性离子水服用医药品。

请勿直接饮用pH10以上的水（强碱性离子水）。

（会造成身体损伤）

- 饮用时，推荐饮用pH9.5左右的“碱性离子水3（日常饮用）”。此外，每日的饮用量大约为0.5L至1L。

请勿饮用以下的水。（会造成身体损伤）

- 酸性水 • 排水管中排出的水
- 清洗中的水 • 酸化水



请勿使用配置的pH值测定液以外的东西。

- 请使用配件和另售品。

请勿使用抗碱性低的铝制容器，和抗酸性低的铜制容器等。

- 容器会变色，或损坏。

## ⚠ 注意

 禁止	<ul style="list-style-type: none"><li>• 主机处，请勿用35℃以上的热水冲洗。（会造成故障）</li><li>• 分歧栓处，请勿用60℃以上热水冲洗。（会造成烫伤，故障）</li></ul>
	请勿用碱性离子水，酸性水，净水，酸化水饲养鱼类等。 <ul style="list-style-type: none"><li>• 环境改变，会造成鱼类等死亡。</li></ul>
	请勿饮用pH测定液或有测定液成分的水，也勿让其进入眼睛。（会造成身体损伤）
	清洗中显示，清洗显示，准备中显示流出的水不能饮用。（会造成身体损伤）
	酸化水是pH2.5左右的强酸性水，是绝对不能饮用的。（会造成身体损伤）
	使用酸化水后，感觉身体出现异样，请立刻停止使用并咨询医生。
	不要在食盐盒中放入不可以使用的食盐。（会造成故障） 关于可以使用的食盐请参照63页“可以使用的食盐”。
	不要保存酸化水。（其产生的氯气，会造成身体损伤）
 禁止烟火	不要将金属餐具或戒指等浸在酸化水中。（会造成生锈，变色）
	pH测定液中含有酒精成分，请勿靠近烟火。（会造成火灾）
 请务必遵守	设置后或长期（大概一周以上）不使用时，开始使用前，确认是否漏水或动作异常。请务必先用配置的pH测定液测定pH值，确定碱性离子水3（pH值大概9.5）未超过pH10后，再进行使用。 之后也请定期（1个月1次以上）进行测定。
	将电源插头从插座上拔出时，请不要拉扯电源接线，请用手拿电源插头然后拔出。（会造成触电，短路，火灾）
	长期（1周以上）不使用时，请务必将电源插头从插座上拔出。
	生成，使用，排放酸化水时，因为会有氯气的臭味，所以请打开换气扇，打开窗户等，保持通风换气。（会造成身体损伤）
	酸化水或从排水管中排出的水进入眼睛时，请马上用自来水冲洗。（会造成身体损伤）
	用不锈钢水槽生成，使用，排放酸化水后，请用自来水冲洗。（会造成水槽变色）
酸化水沾到衣物或头发上时，请用自来水冲洗。（会造成褪色）	

## ● 区分4种水 请根据用途正确使用。

		功 能		pH值大至标准
pH 调整 按钮	碱性离子水	强	灰汁强性食材(牛蒡, 蒟蒻等)时 <b>⚠注意</b> 请勿直接饮用。	10~11
		3	日常饮用, 喝咖啡, 红茶, 或煮东西, 煮汤等时。	9~9.9
		2	已经习惯饮用时, 或煮饭等时。	8.5~9.5
		1	开始饮用时。	8~9
	净水	滤芯过滤水。 服药, 冲泡奶粉, 饮用等时。 ※未电解。	—	
	酸性水	洗脸。 <b>⚠注意</b> 请勿饮用。	4.5~6.5	
	酸化水	通水管或砧板等清洗。 <b>⚠注意</b> 请勿饮用。	2.5~3.5	

## ● 零废水模式装载

“零废水”指示灯亮时, 表示生成开始时的废水为零, 可以马上使用。

## ● 易查看的液晶显示

- 通过液晶显示, 一眼就能确认使用中的水的情况。
- 显示pH, 水素含量, 总流量, 滤芯可以使用的最大通水量。

## ● 只需操作一个按钮, 就可装载提升电解能力的“水素增加模式”和“Hi模式”

可在pH值较难上升的地区简单设定

pH测定值比pH值的大至数值低时, 请使用“水素增加模式”。

同时水素产生量也会增加。

即使使用了“水素增加模式”, pH值还未能进入大至数值的范围时, 请使用“Hi模式”。

※根据水质或使用条件不同, pH值上升幅度有差异。

### ● 什么是水的pH

表示水中的水素离子浓度, 水呈酸性还是碱性的一个指标。

酸性                                  中性                                  碱性  
(数值小)                                  ← (7) →                                  (数值大)





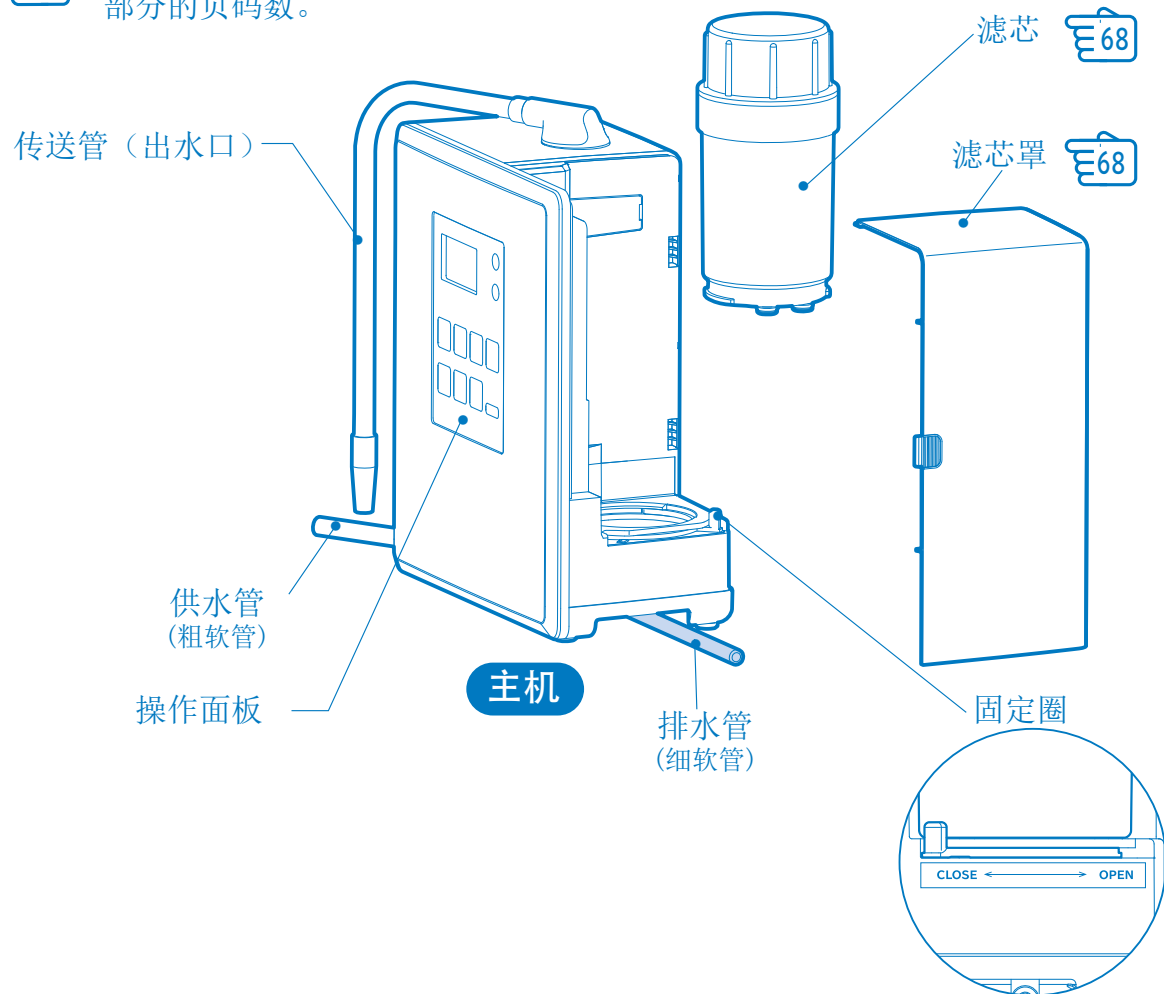

### ● 什么是水素含量

显示由于水的电解而产生的碱性水素含量的大至数值。

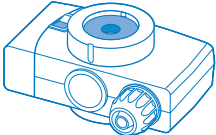
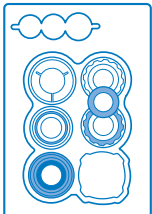
 中的数字为详细说明部分的页码数。

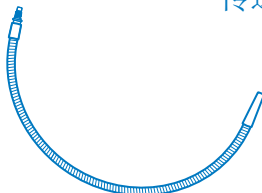
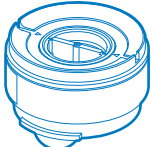

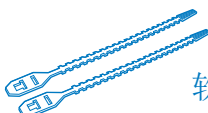
## <配件>

	分歧栓		用于安装分歧栓配件		滤芯 更换贴签 1张
	传送管		食盐盒 (食盐计量用带“勺”)		食盐 (酸化水生成辅助剂) 1包 5克 (有3包)
	吸盘 (用于固定排水管)		软管固定带 2根		pH测定液组合 pH测定液 pH变色对照表 专用杯

# 各部件的名称

## <操作面板>

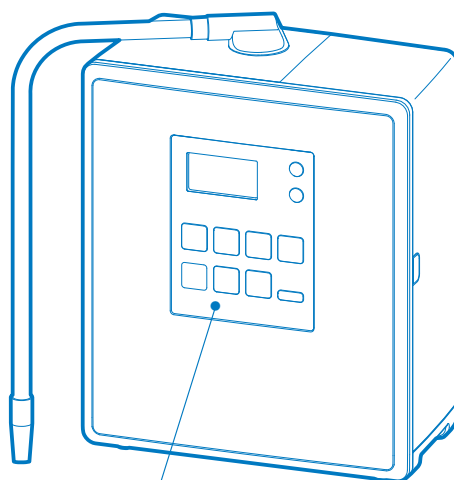

操作面板

中的数字为详细说明部分的页码数。

### 液晶显示内容



※没有全部同时显示的情况。

- ..... 生成中
- ..... Hi模式
- ..... 水素增加
- ..... 准备中
- ..... 清洗中
- ..... 清洗
- 目安表示 ..... 大概标准
- L/分 ..... L/分
- まで絞る ..... 调整流量, 使其不超过液晶显示区显示值(L/min)。

### 液晶显示区

从传送管中传送的水的pH值(净水时显示“—”), 水素含量, 传送管, 排水管中的水相结合的总流量, 还有滤芯可以使用的最大通水量。(上述数值为大概标准)

※实际生成的水, 由于受水质, 流量变动的影晌, pH值, 溶存水素量可能会不稳定, 通水量也可能产生误差。

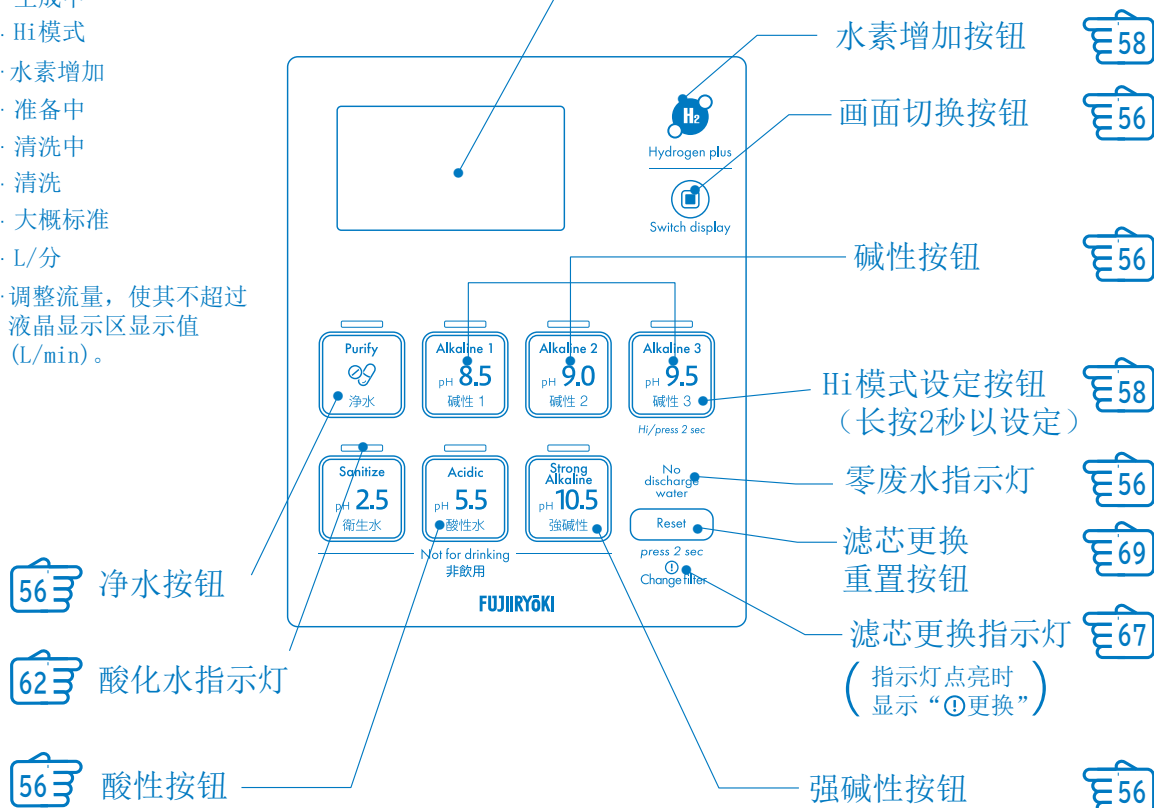

## &lt;安装完成图&gt;

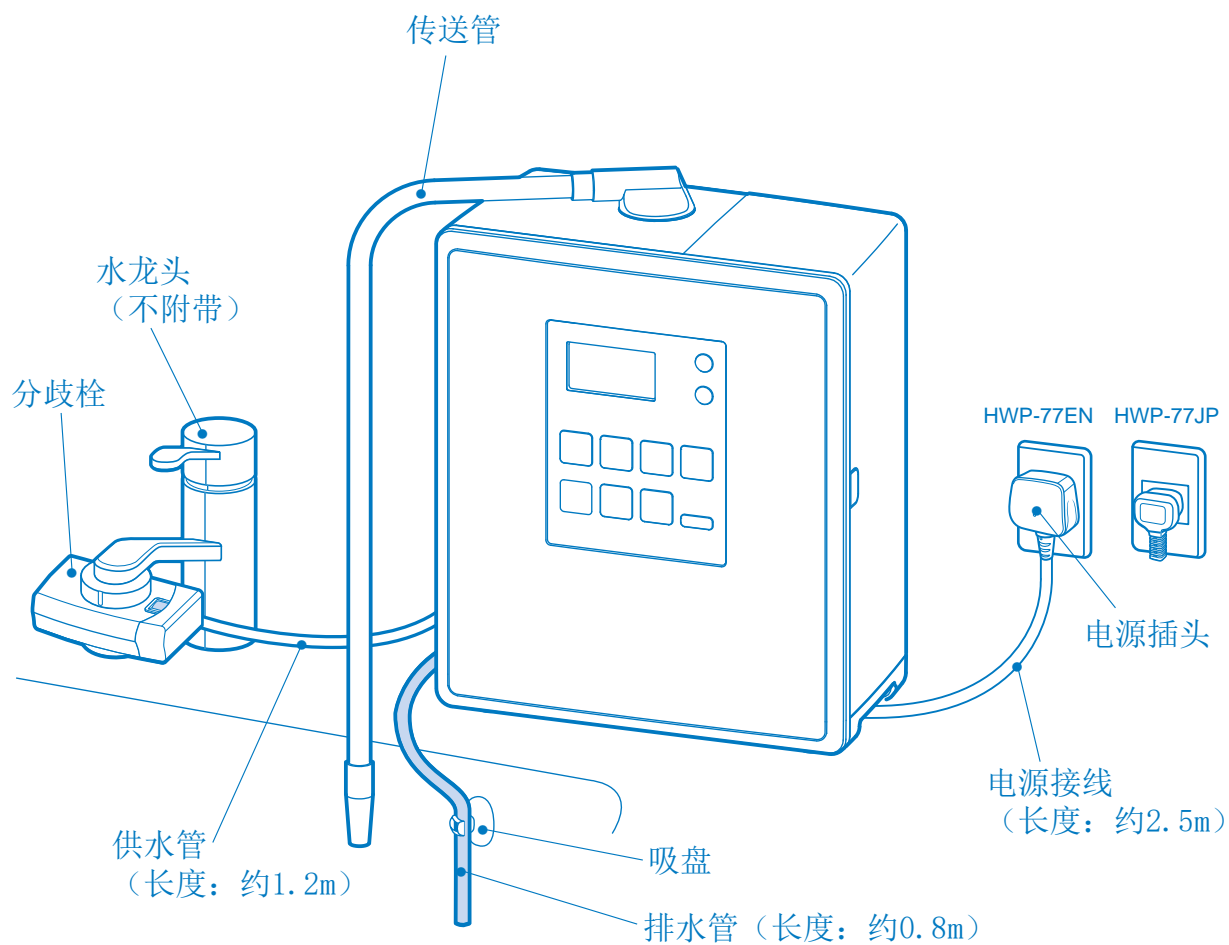

※请设置在水槽周围平稳的位置。

# 各部件的名称

## < 分歧栓 >

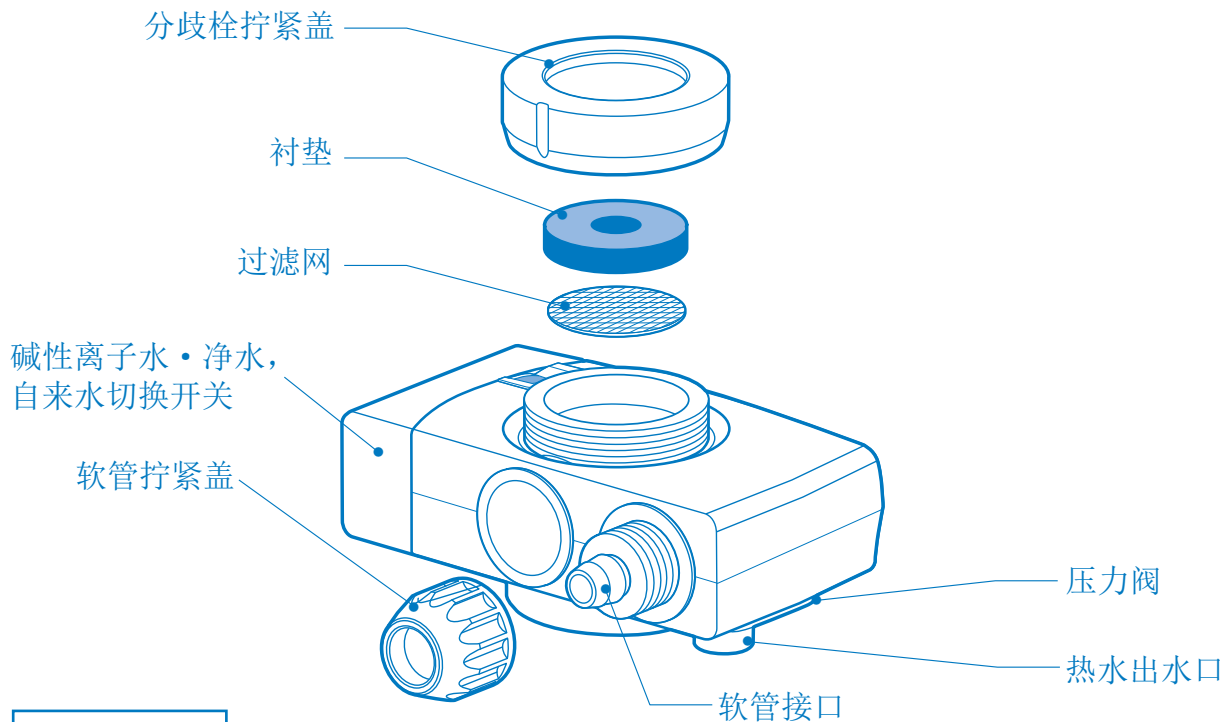

### 功能

- 分歧栓拧紧盖 ..... 把分歧栓固定到水龙头上。
- 衬垫 ..... 防止连接分歧栓和水龙头的地方漏水。
- 过滤网 ..... 垃圾等堵塞会导致水量减少。“自来水”“碱性离子水·净水”的水量减少或者长时间（6个月以上）使用的话，请用牙刷等把过滤器中的污垢清除掉。
- 碱性离子水·净水，自来水切换开关 ..... 可切换“碱性离子水·净水”（Ion）“自来水淋浴”（) “自来水直流”（Raw）。
- 压力阀 ..... 机器内部的水压过高时，阀门会打开放水。（约500kPa）
- 热水出水口 ..... 压力阀出水时，是因为水压过高，所以请关小自来水的水龙头。打开“碱性离子水·净水”的开关时，50℃以上的热水会流出。
- 软管接口 ..... 连接供水管。
- 软管拧紧盖 ..... 把供水管固定在软管接口上。

## ● 碱性离子水·净水，自来水切换开关的使用方法

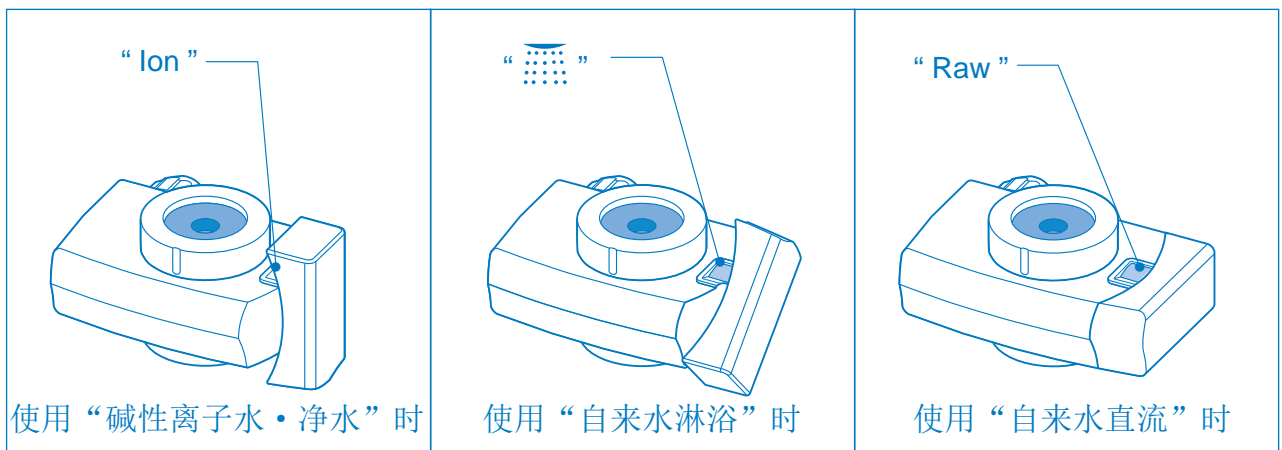



## ⚠ 注意







请务必遵守

使用碱性离子水・净水时保持水温低于35℃。（会造成故障）

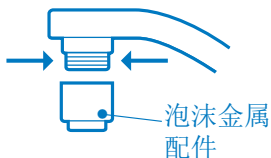
选择与水龙头的螺丝直径吻合的安装用的配件使用。（会造成漏水）

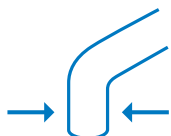
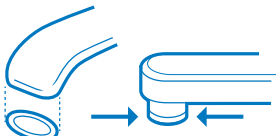
下列水龙头，不能用于安装。

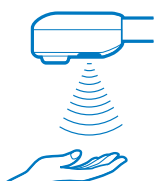
<p>螺丝的直径不同 22mm以外</p>	 <p>泡沫金属配件</p>	<p>带淋浴</p>	
<p>水龙头直径 25mm以上</p>		<p>变形 特殊口径的螺丝</p>	
<p>前端长15mm以下</p>		<p>带传感器</p>	

# 分歧栓的安装方法

通知

塑料制的水龙头，可能会造成安装的地方漏水。请更换水龙头。

安装这个部件

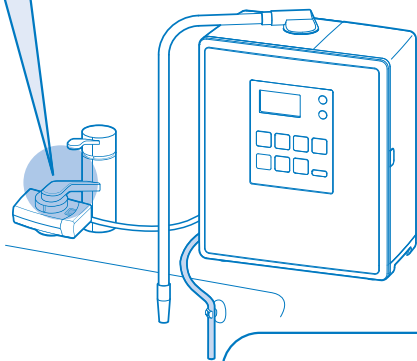

水龙头前端有泡沫金属配件的话

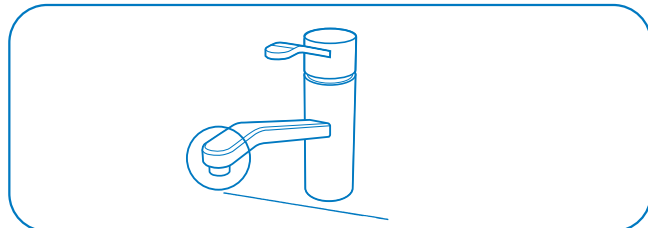

取下全套泡沫金属配件



用硬币等拧外螺纹或者内螺纹配件，把分歧栓拧紧盖安装到水龙头上。

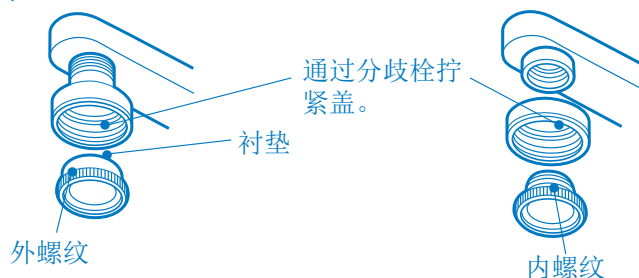

从下面把分歧栓放平，拧紧分歧栓拧紧盖。

分歧栓拧紧盖

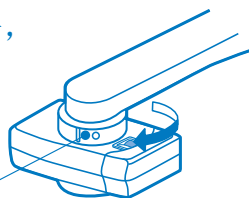

注意

不要使用工具安装分歧栓拧紧盖。（会造成破损）

### 水龙头的前端有凸起部分时

用分歧栓安装配件的衬纸，测量水管的直径，选择固定用的圈。

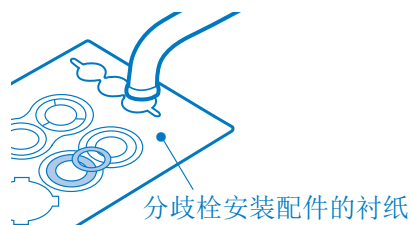

分歧栓拧紧盖穿过水管。

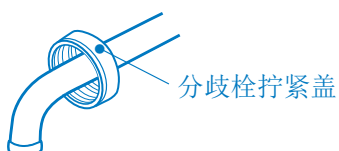

把固定用的圈套在水管的前端。

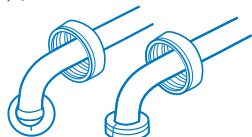

把固定用的圈的接缝放到面前的话，更容易安装。

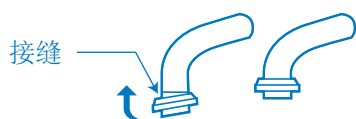

把分歧栓水平抵在水龙头上，拧紧分歧栓拧紧盖。

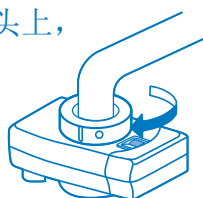

#### 注意

不要使用工具安装分歧栓拧紧盖。  
(会造成破损)

### 水龙头的前端没有凸起部分时

固定螺丝的金属配件的安装方法。  
※本产品不附带固定螺丝的金属配件。  
请到商店购买。(16mm, 17.5mm, 19mm的  
分歧栓安装用的配件无法匹配时)

拧下螺丝，金属配件穿过分歧栓拧紧盖。

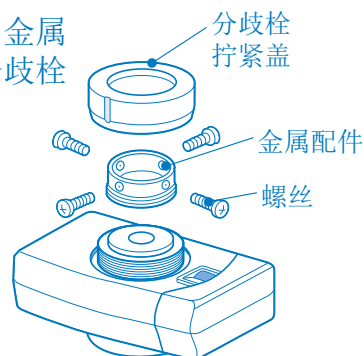

再次安装螺丝。

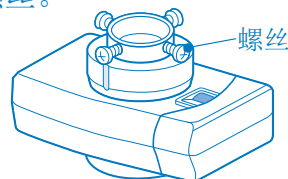

弄松螺丝，把分歧栓水平抵在水龙头上，拧紧螺丝。  
不要过度拧螺丝。  
(可能会穿透水龙头管壁。)



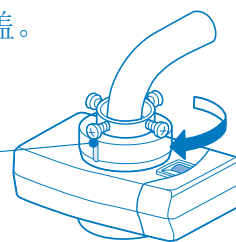

安装分歧栓拧紧盖。

分歧栓拧紧盖



# 主机的设置

## ⚠ 注意

 <p>请务必遵守</p>	<p>请将主机水平放置。禁止放在摇晃的台子上或倾斜的地方，不稳定的地方等。 (会掉落，倾倒，可能造成受伤)</p>
 <p>禁止</p>	<p>请勿放置在以下场所。(会造成变形，变色，错误运作，故障)</p> <ul style="list-style-type: none"><li>• 使用火源之处，或者高温物品(60°C以上)的附近。</li><li>• 微波炉，电磁炉，冰箱上或其附近。</li><li>• 阳光直射之处。</li><li>• 室外或风吹雨打之处。</li><li>• 可能结冰之处。</li><li>• 沾油之处。</li><li>• 浴室或有水，水蒸气之处。</li></ul>
	<p>不要用商店出售的软管延长出水口。(会造成故障)</p>
	<p>不要将其他机器接到供水管，排水管上。(会造成漏水或故障)</p>
	<p>不要堵塞出水口，弯折，拧，弄坏水管。 (会造成pH值无法达到设定数值，漏水或故障)</p>
	<p>不能设置在设有逆止阀(防止水流逆流的阀门)的提供热水的设备上。 (会导致提供热水的设备发生故障)</p>
	<p>不能安装于热水专用的水龙头上。(会造成故障)</p>
	<p>机身不要压到电源接线，供水管，排水管。(会造成漏水或故障)</p>

## 电源接线，供水管，排水管的拉出方法

根据设置位置决定拉出电源接线，供水管，排水管左右中的一个方向。

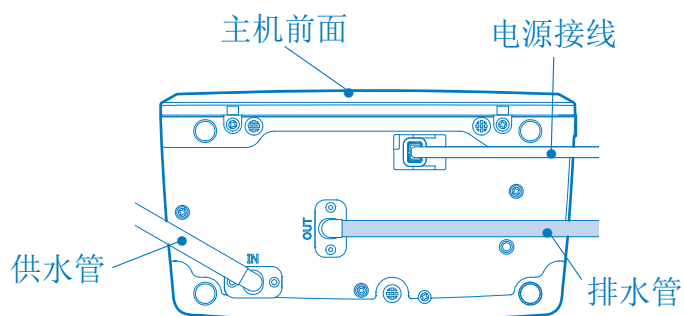

- 可以从供水管，排水管根部旋转。

## 食盐盒的设置

将食盐盒置于主滤芯上面。

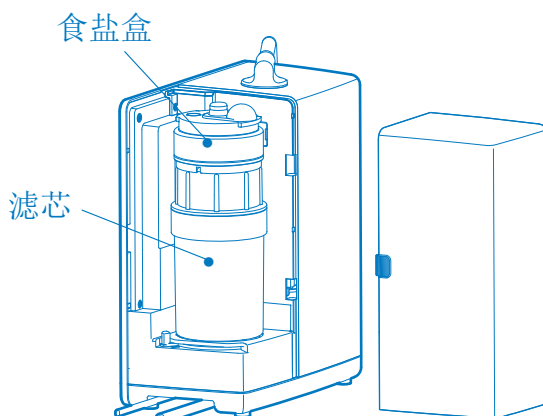

## 传送管的安装

### ⚠ 注意



禁止

不要用水管等延长出水口。（会造成漏水或故障）

插入的部分为塑料材质，所以不要强行插入。（会造成漏水或故障）

### 请注意

- 安装完后，要弯折传送管时，请提起管口，用另一只手弯折水管。

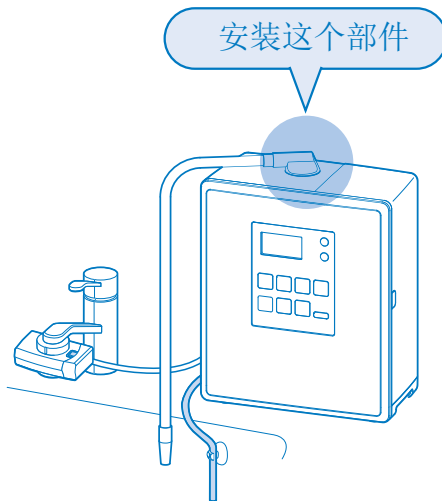

把传送管插紧。

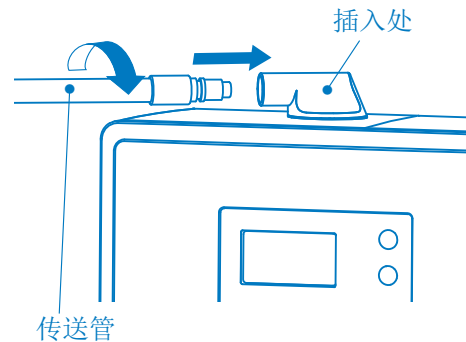

## 排水管的安装

### 请注意

- 传送管的底端与排水管底端的高低差为15cm到40cm（不包括40cm）。  
（为了得到合适的pH值）
- 排水管放在比主机底部低的位置。
- 排水管过长时，请切掉。
- 不要使排水管弯曲过大以致折断。
- 请不要延长排水管。

把排水管用吸盘固定到水槽上。

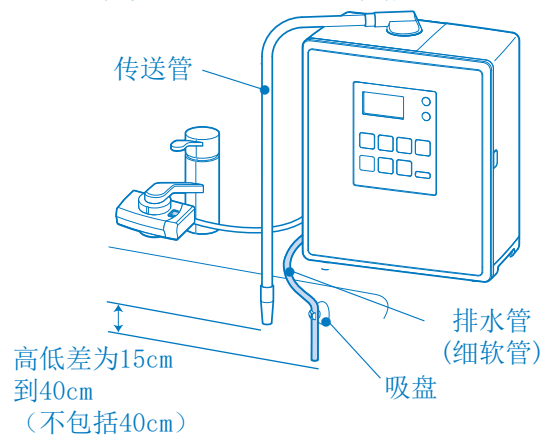

# 主机的设置

## 供水管的安装

### ⚠ 注意



禁止

不要弯折，强拧供水管。（会造成漏水）

不要连接热水专用的水龙头。（会造成故障）

连接混合水龙头时，不要使用热水（35℃以上）。（会造成故障）

### 提示

- 在水龙头上安装分歧栓时，请给供水管预留出水龙头可以左右移动的位置。

安装这个部件

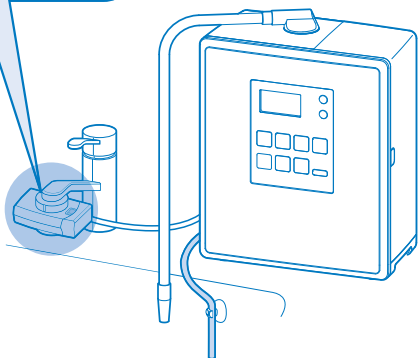

- 供水管过长时，推荐您截短后使用。

1

把软管拧紧盖从分歧栓上取下来，穿过供水管。（①）

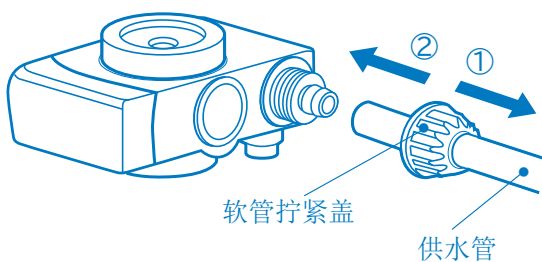

3

用力拧紧软管拧紧盖。

- 不要使用工具。（会造成分歧栓破损）

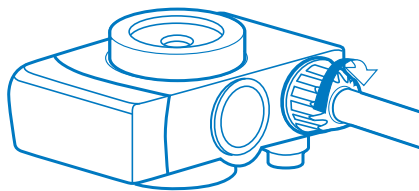

2

插紧供水管（②）

正确的示范

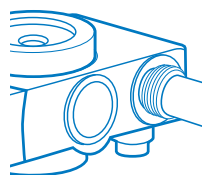

错误的示范

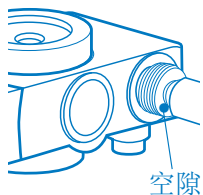

4

用软管固定带固定供水管。

- 固定时，不要弄坏水管。

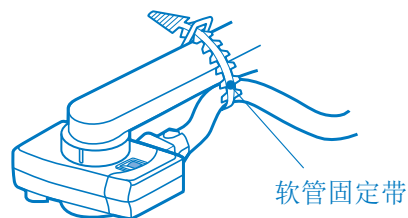

安装完毕后，首次通水前请务必执行以下操作。

- 打开滤芯罩，确认滤芯已正确安装。
- 在将电源插头插入插座之前，请先通一次水。

- 1 将碱性离子水·净水，自来水切换开关切换到“碱性离子水·净水”（Ion）一侧，打开水龙头。

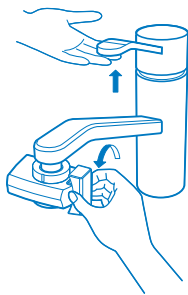

- 2 放水至水变透明。

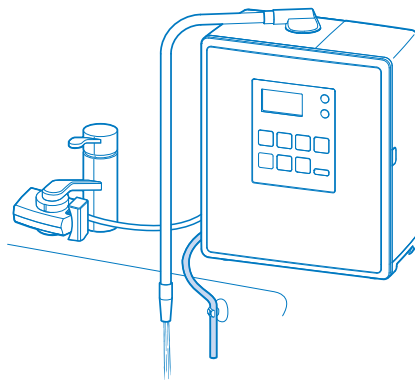

- 若有水从分歧栓的压力阀渗出，则水压偏高，请关小水龙头。
- 若不出水，请查看本机“碱性离子水，酸化水”的切换开关是否已经切换。
- 切换分歧栓的开关时，请务必先关水。（会造成机器故障。）

## 使用碱性离子水，酸性水，净水

继续

### ⚠ 注意



禁止

- 请勿在液晶“准备中（準備中）”显示闪烁时使用。
- 主机内残留水未排出干净前，“准备中（準備中）”显示会闪烁。
  - 闪烁时间随根据，水流量有变化。

### 提示

- 修理水管后自来水可能会变浑浊，此时请将分歧栓切换到“自来水”（Raw）一侧，等水变透明后再开始使用。  
（会造成滤芯堵塞）
- 请勿在拔下电源插头的情况下使用。  
（电源切断期间，流量和使用时间将不会被记录，导致滤芯的使用寿命无法正确计算，更换滤芯的时间判断会产生误差。）

# 使用碱性离子水，酸性水，净水

## 使用方法

**1** 将电源插头插入插座，按下想要选择的pH调整按钮。

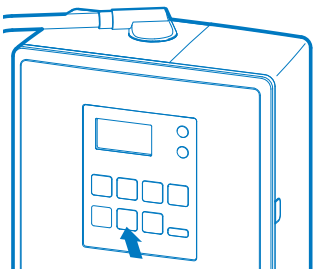

**2** 将切换开关切换到“碱性离子水·净水” (Ion) 一侧，打开水龙头。



**3** 液晶显示从“准备中（準備中）”转变成“生成中”，报警音鸣响“哔”声后方可开始使用。

- 使用“净水”功能时，排水管不会排水。
- 使用“强碱性”，“酸性水”并关水后，再次使用时，为防止误饮，pH值将自动跳回最近使用过的饮用碱性1，2，3或净水模式。
- 使用“强碱性”，“酸性水”时，警告音将持续鸣响。

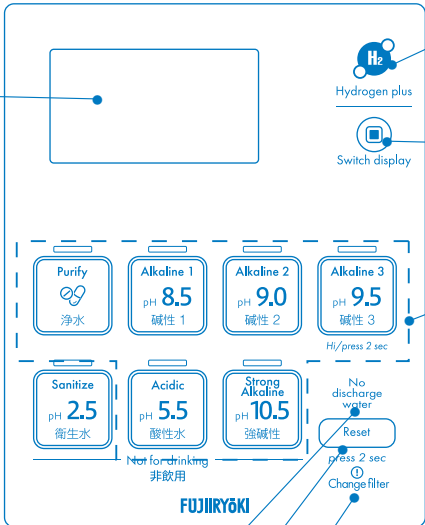

液晶显示区

水素增加按钮  
设定水素增加模式时按下该按钮。

画面切换按钮  
每按下一次按钮顺序显示“水素量→流量→滤芯剩余量”。

pH调整按钮  
按下后可以选择水质。  
被按下的按钮上面的指示灯会点亮。

零废水指示灯

滤芯更换重置按钮

滤芯更换指示灯

pH调整按钮	用途
强碱性 Strong Alkaline pH 10.5 强碱性	—— (非饮用)
碱性3 Alkaline 3 pH 9.5 碱性 3 H <sub>2</sub> /press 2 sec	日常饮用 (饮用)
碱性2 Alkaline 2 pH 9.0 碱性 2	习惯饮用 (饮用)
碱性1 Alkaline 1 pH 8.5 碱性 1	初期饮用 (饮用)
净水 Purify 净水	—— (饮用)
酸性水 Acidic pH 5.5 酸性水	洗脸 (非饮用)

### 零废水指示灯

点亮时，继续使用之前用过的碱性1，2，3或净水的水质时，刚开始通水时“准备中（準備中）”显示将不会闪烁（即不产生废水），可以立即使用。

继续饮用碱性离子水或用水淘米时变得十分方便。

- “零废水指示灯”在关水约30分钟后会熄灭。
- 选择强碱性，酸性水时不会点亮。

※关于其它利用用途，请参照44页“为了您能更好地使用”。



## 碱性离子水

按下碱性1, 2, 3或强碱性按钮, 即可使用从传送管中流出的“碱性离子水”。

## 酸性水

按下酸性水按钮, 即可使用从传送管中流出的“酸性水”。

- 排水管中流出的水碱性较强, 不可使用。

### 请注意

- 使用“酸性水”时, 如水量过小※, 则有可能流出低于显示pH值的酸性水。虽然液晶显示区会显示标准值pH5.5, 但还是请使用pH测定液进行确认。  
※水量过小具体是指出水口流量达到1.5L/分左右, 即6秒钟可灌满一杯的状态。

## 净水

按下净水按钮, 即可使用从传送管中流出的“净水”。

- 排水管不会排水。

## 4 使用完毕后, 请关紧水龙头, 并将分歧栓切换到“自来水”一侧。

- 关水后, 作为滤芯更换的大概标准在液晶显示可以使用的最大通水量。

<显示例>

使用中

显示选择的模式的pH值

待机中

显示滤芯更换的大概标准



- 关上水龙头后, 液晶显示约1分钟后熄灭。  
关水30分钟后所有的指示灯会熄灭, 变成节电模式。  
如果再次按下按钮或通水时, 指示灯则再次点亮。

### 通知

<显示例>

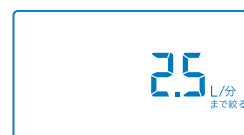

- 如果流量过大, 液晶上会持续显示关小流量的闪烁状态。此时, 请慢慢关小水龙头, 直到显示转变(设定的pH点亮)。
- 如果有关小流量闪烁显示时, 按下“画面切换”按钮, 就会闪烁显示现在的流量。  
将水龙头关到正常流量时, 指示灯变成点亮显示。

# 碱性离子水的 pH 值偏低时

安装后请按照64页的“测定pH值”测定碱性离子水的pH值。当测定值低于显示的pH值时(参照64页的“通知”)

- 来水中的碳酸影响导致pH值偏低时, 请正常使用。
  - 由于受水质影响导致pH值偏低时, 请设定“水素增加模式”或“Hi模式”。
- “水素增加模式”可以提高“碱性1, 2, 3”, “强碱性”的pH值。  
“Hi模式”可以提高“碱性1, 2, 3”的pH值。

如果选择“水素增加模式”后pH值依旧低于大概标准时, 请选择“Hi模式”。

※根据水质和使用条件, pH值的上升幅度是有限的。选择上面两个模式后, 请重新测定pH值。

## 水素增加模式

### [设定]

“碱性”, “强碱性”模式时

在不通水的状态下, 按下“水素增加”按钮。在液晶上水素增加标记点亮。

※通过“碱性”, “强碱性”模式可以设定水素增加模式。

※在以下情况, 不能选择“水素增加”按钮。(会鸣响哗哗哗的警告音。)

- 设定“Hi模式”时
- “净水”模式
- “酸性水”模式
- 通水中

※设定水素增加模式时, 在“碱性1, 2, 3”和“强碱性”状态下变成水素增加模式。

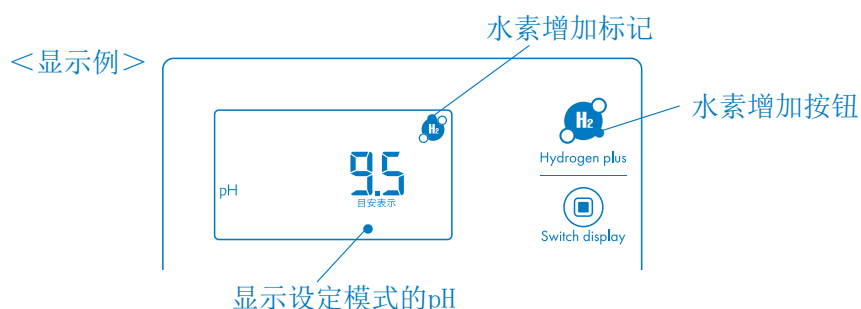

### [解除]

在不通水的状态下, 按下“水素增加”按钮。水素增加标记将会熄灭。

## Hi 模式

### [设定]

在不通水的状态下, 长按2秒以上“碱性3”按钮。

直到液晶上点亮Hi模式标记。设定“Hi模式”时, 在“碱性1, 2, 3”状态下变成“Hi模式”。

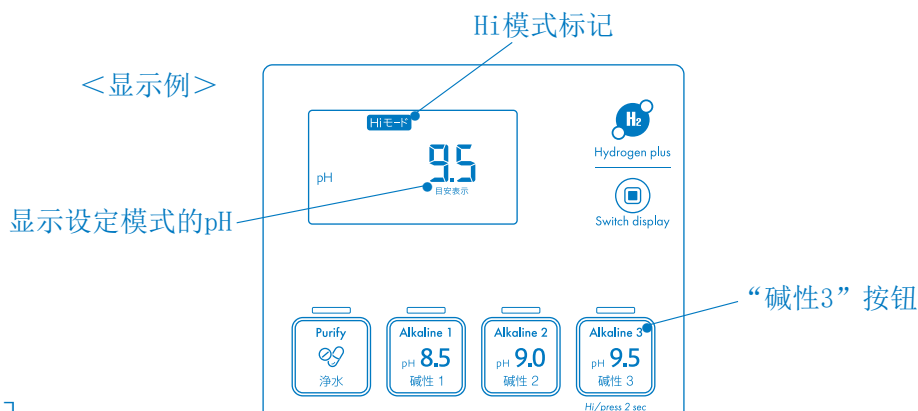

### [解除]

在不通水的状态下, 长按2秒以上“碱性3”按钮。

Hi模式标记将会熄灭。

# 画面切换（水素浓度，流量，滤芯剩余量）

生成中按“画面切换”按钮，按顺序切换“水素浓度→流量→滤芯剩余量”画面。

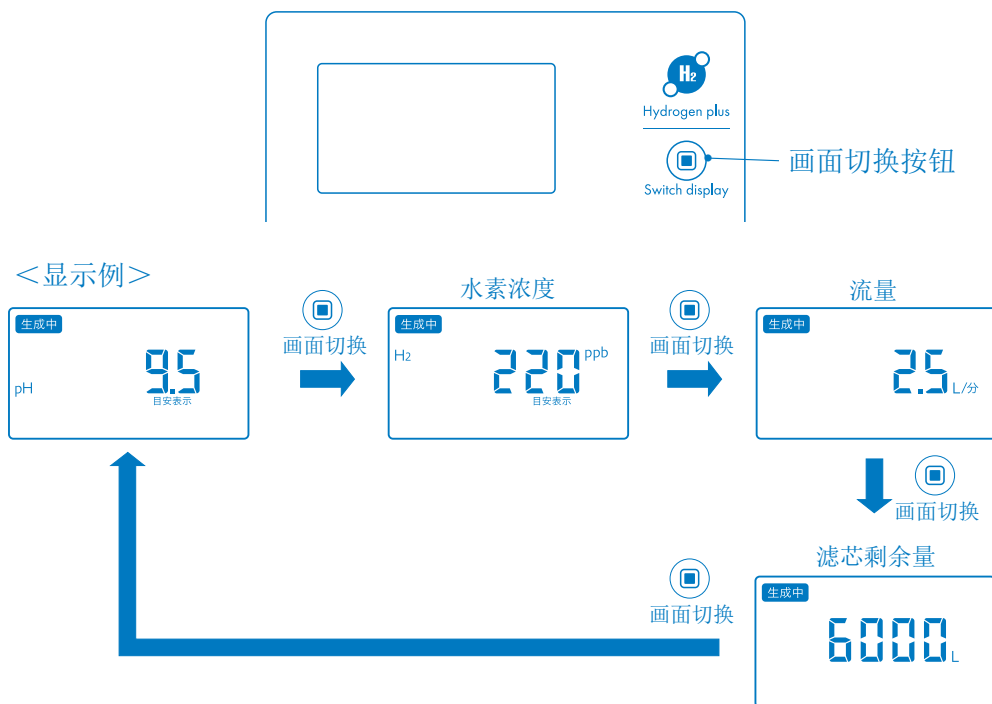

- 显示pH值，水素浓度的大概标准。根据水质与实际数值会有不同。
- 只有“碱性”，“水素增加”，“Hi模式”显示水素浓度。

# 查看滤芯的使用寿命 ( 剩余量 )

作为滤芯更换的大概标准，在液晶显示区显示可以使用的最大通水量和可以使用天数。

- 可以使用的最大通水量为8,000L。(滤芯的过滤能力)  
※使用开始时为8,000L，每通水一次按照1L(升)为单位减法的计算显示剩余量。
- 可以使用天数为730天。(考虑酸化方面推荐最长使用期限约2年)  
※从开始使用起约2年，剩余天数在14天以下时将同时显示可以使用的最大通水量。
- ※待机状态下也会显示计算天数，如果拔掉电源插头会产生误差。
- 关于滤芯更换指示灯和液晶显示内容(可以使用的最大通水量及使用天数)的关系，请参照67页的“滤芯的更换”。

## 自动显示进行确认

- 关水后，可以自动显示剩余量。

<显示例>

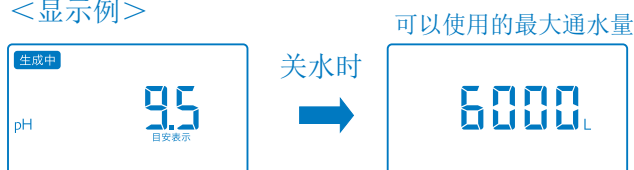

※可以使用天数在14天以下时也会显示天数。

<显示例>



## 按下画面切换按钮进行确认

- 通过按下画面切换按钮，可以显示剩余量。

<显示例> 节电时

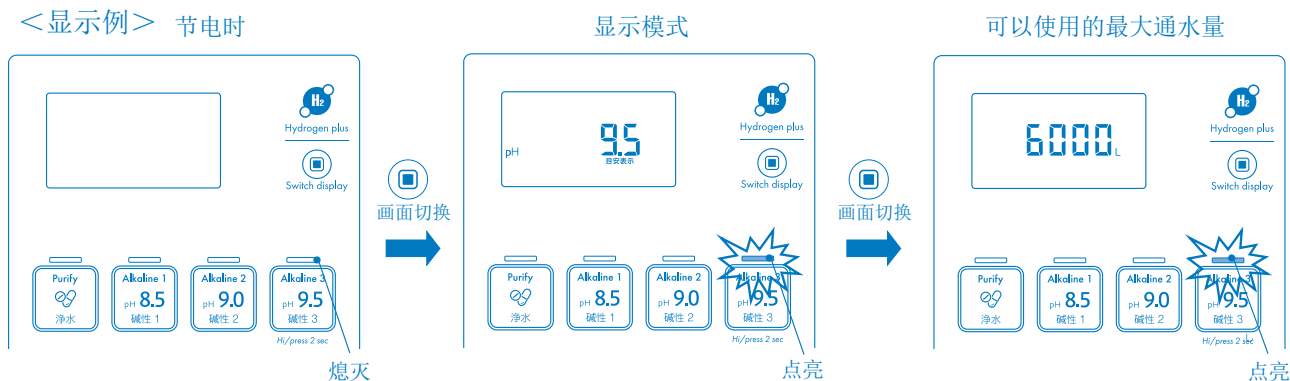

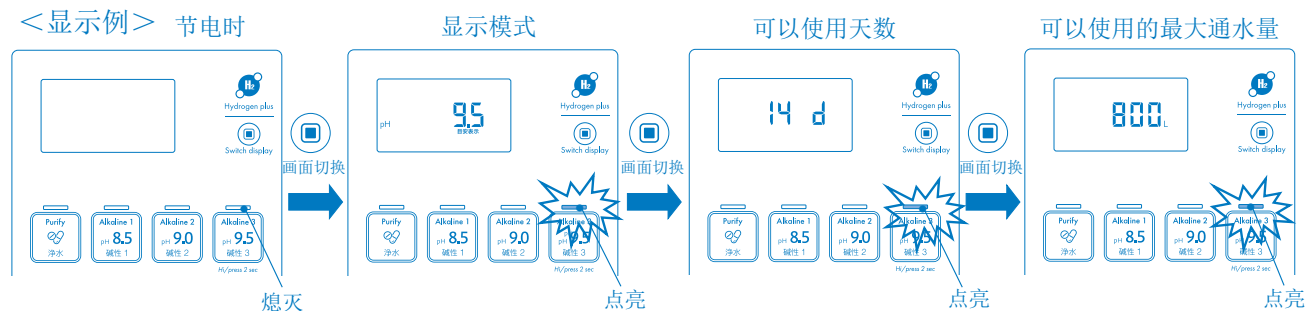

※可以使用天数在14天以下时也会显示天数。

<显示例> 节电时



酸化水：用于清洗通水管。

## ⚠ 注意

 <p>禁止</p>	酸化水是pH2.5左右的强酸化水，所以绝对不能饮用。 (会造成身体损伤)
	使用酸化水后，感觉身体出现异样，请立刻停止使用并咨询医生。
	不要在食盐盒中放入不可以使用的食盐。(会造成故障) 关于可以使用的食盐请参照63页“可以使用的食盐”。
	不要保存酸化水。(酸化水产生的氯气会造成身体损伤)
	不要将金属餐具或戒指等浸泡在酸化水中。(会造成生锈，变色)
 <p>请务必遵守</p>	生成，使用，排放酸化水时，因为会有氯气的臭味，所以请打开换气扇， 打开窗户等，保持通风换气。(会造成身体损伤)
	酸化水或从排水管中排出的水进入眼睛时，请马上用自来水冲洗。
	用不锈钢水槽生成，使用，排放酸化水后，请用自来水冲洗。 (会造成水槽变色)
	酸化水沾到衣物或头发上时，请用自来水冲洗。 (会造成褪色)

1

确认是否关水。  
取下滤芯罩，取出食盐盒。

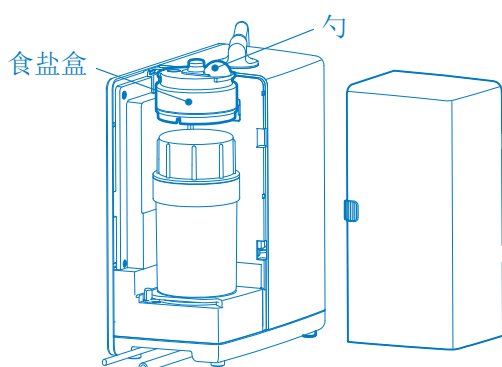

2

取下勺，向左旋转拔下盖。

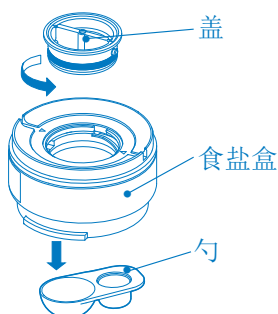

3

将配置的食盐放入食盐盒，向右旋转  
直至食盐盒和盖的△部分呈一致  
后拧紧食盐盒。  
(未拧紧时会造成漏水。)

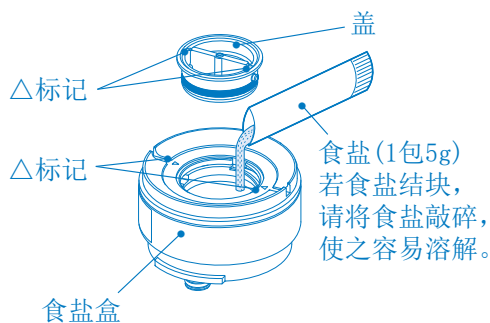

请配合生成的酸化水的水量来判断食盐用量。

- 食盐约5g (约1勺) 酸化水约1L
- 食盐约10g (约2勺) 酸化水约2~3L
- 食盐约15g (约3勺) 酸化水约4~5L

# 酸化水的生成

- 4 将固定圈旋转到OPEN (打开) 位置，取下滤芯。

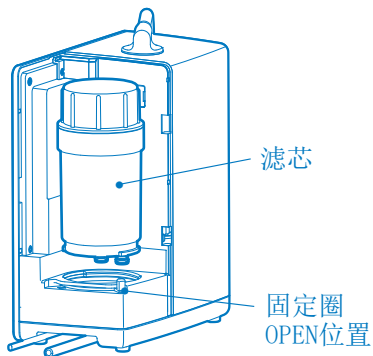

※如果拔不动时，从上面按下主机，将滤芯前后轻轻晃动后拔出。  
(滤芯底部会有水流出，请注意。)

- 5 在主机上安装食盐盒，将固定圈旋转到CLOSE (锁紧) 位置。

(将主机管的孔和食盐盒的管对准，确实完全插入到底。)

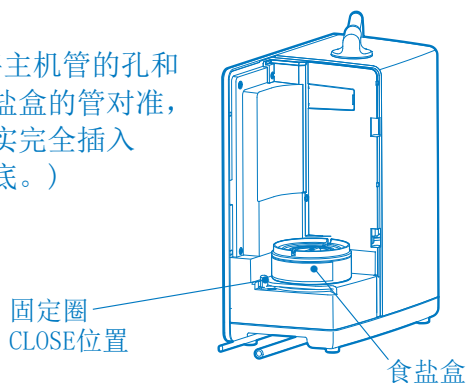

- 6 确认酸化水指示灯闪烁后，安装滤芯罩。



- 7 打开水龙头。  
液晶显示区将闪烁约3秒，然后开始生成“酸化水”。  
生成中液晶显示区变成点亮。

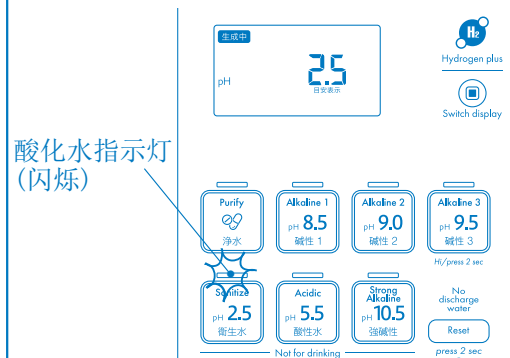

<如果液晶显示区没有变成点亮时>

- 食盐盒中没有食盐。  
请加入食盐。
- 食盐因结块而无法溶解。  
请更换食盐。

- 8 “酸化水”生成后，食盐全部溶解后，将会自动开始约30秒的清洗。  
清洗过程中非酸化水。  
通过清洗将水管内剩余的食盐冲洗干净。  
清洗完毕之前请勿关闭水龙头。

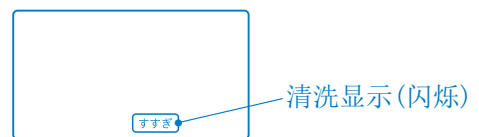

- 使用“酸化水”或进行清洗时，警告音会持续鸣响。
- 酸化水指示灯闪烁时，不能使用其它的“碱性离子水”，“净水”或“酸化水”。

- 9 清洗完毕后，关闭水龙头后取下食盐盒。

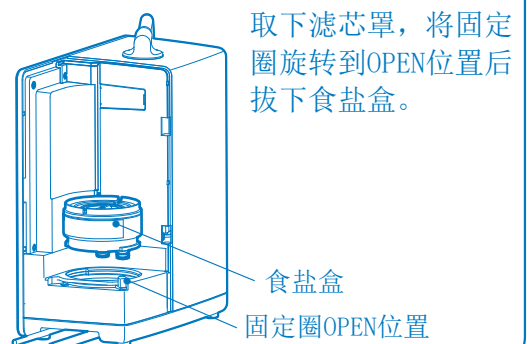

取下滤芯罩，将固定圈旋转到OPEN位置后拔下食盐盒。

- 10** 对准主机管的孔和滤芯管后，将固定圈旋转到CLOSE(锁紧)位置。

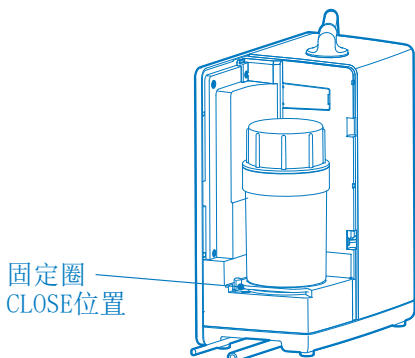

- 11** 将食盐勺安装在食盐盒上，并置于滤芯上安装滤芯罩。

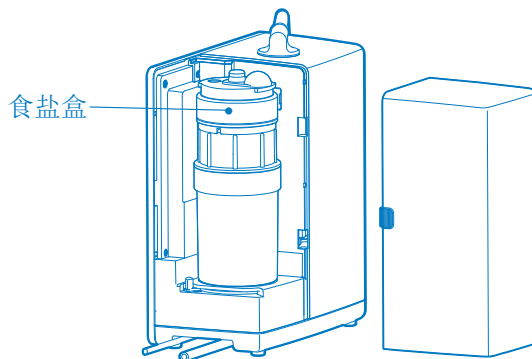

### 可以使用的食盐

除配置的食盐外，也可以使用氯化钠或盐分含量99%以上的食盐。

### 食盐用量和酸化水生成量的大概标准

以食盐盒上的刻度为大概标准，根据需要生成的酸化水的量加入食盐(或氯化钠或盐分含量99%以上的食盐)。(参照61页的“酸化水的生成”③)

- 使用配置的食盐外时，使用食盐计量用带“勺”(5g)十分便利。
- 如加入的食盐过多，多余的食盐会在食盐盒中结块，可能会导致酸化水无法生成。

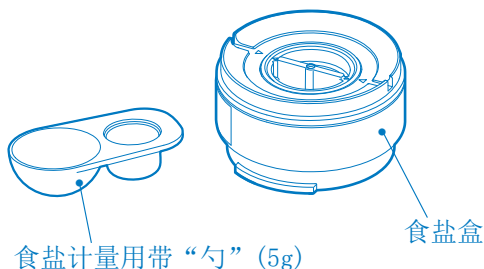

### 如果食盐结块了

如果将多余的食盐留在食盐盒中，食盐会结块，可能导致下一次生成酸化水时食盐无法溶解，最终无法生成酸化水。

(即使在食盐盒中加入新的食盐，液晶显示区也会不停闪烁，无法生成酸化水。)

此时，请用自来水冲洗掉结块的食盐，然后再在食盐盒中加入新的食盐。

## 使用时的注意点

- 在水质较硬的地区※使用时，每天开始使用前请通酸性水1分钟左右。(出水口和水管中附着钙，影响正常出水。)  
※水质较硬的地区：会发生肥皂难以起泡，水壶和锅上易附着白色物质(钙)等现象的地区。
- 请勿使用海水等含有盐分的井水(靠近海岸的井水)。  
※可能会发生“清洗(すすぎ)指示灯”持续闪烁，无法生成碱性离子水的情况。
- 请勿通过拿住传送管，滤芯或食盐盒的方式举起主机。(会造成故障。)

# 测定 pH 值

## ⚠ 注意



禁止

请勿饮用pH测定液或含有pH测定液的水，或使其误入眼中。  
(特别是儿童，请务必注意。)会造成身体损伤。

- 若不慎误饮，请大量喝水，并尽快就医。
- 若不慎误入眼，请使用大量的水冲洗，并尽快就医。
- 请务必盖好瓶盖，放在儿童无法接触的地方避光低温保存。



禁止烟火

因pH测定液中含有酒精类，因此请勿靠近烟火。(会造成火灾)

- 设置后或长期(大概一周以上)不使用时，开始使用前，请务必先用配置的pH测定液测定pH值，确定碱性3 (pH值大概9.5)未超过pH10后，再进行使用。此时，请解除水素增加模式。之后也请定期(1个月1次以上)进行测定。
- 为测定稳定的pH值，请在液晶显示准备中(準備中)变成生成中，放水5秒以上后使用配置的专用杯收集用于测量的碱性离子水。

1

将碱性离子水倒入专用杯并冲洗2~3次，然后倒至刻度。

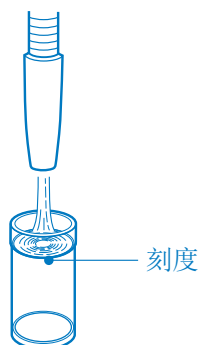

3

将变色的水色和pH变色对照表的颜色相比较，相同颜色的数值就是碱性离子水的pH。

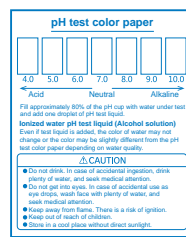

pH变色对照表

2

将1滴pH测定液滴入碱性离子水，轻轻晃动杯子。



## 通知

- 部分地区使用地下水作为水源，请注意在这种情况下自来水中可能会含有大量碳酸。受碳酸影响，选定的pH值与使用pH测定液测定出的实际pH值可能会不相符。请参照72页的“使用pH测定液测定碱性离子水的pH值时水不变蓝色或深蓝色”中记载的原因和解决方法，确认自来水中是否含有碳酸。
- 受水质影响，碱性离子水的pH值可能出现无法上升的情况。此时请尝试以下方法解决。
  - 选择“水素增加模式”或“Hi模式”。(参照58页)
- pH值过高时，请尝试以下方法解决。
  - 选择相对较弱的碱性模式。
  - 在使用时掺入净水。
- 不能测定酸化水的pH值。

## 请注意

- 一段时间过后，试验水的颜色会产生变化。因此，滴入pH测定液后请立即与pH变色对照表进行比较。
- 丢弃pH测定液的原液时，请掺入水后倒入下水道系统。
- pH测定液和pH变色对照表受阳光照射后会变色，请保存在阴暗处。



# 主机内部的清洗

- 为了清除主机内电极板上附着的钙，维护正常的制水功能，会进行电极自动清洗。

“碱性1, 2, 3”，“强碱性”的总通水量超过10L的情况。

关闭水龙头。或将碱性离子水·净水，自来水切换开关切换到“自来水” (Raw) 一侧。

约30分钟之后

开始电极板的自动清洗。(约40秒钟)  
清洗过程中液晶上显示“清洗中(洗净中)”。  
清洗结束后，“清洗中(洗净中)”显示熄灭，  
清洗的水从排水管排出。



自动清洗结束后再通水时，在排出清洗的水之后，开始生成新水。  
※清洗的水在排出时，液晶上“清洗中(洗净中)”及“准备中(準備中)”指示灯会闪烁，并发出报警音。  
(清洗中约6秒钟+准备中)  
在此期间请勿使用。

## 请注意

- 自动清洗中通水时，显示屏的“准备中(準備中)”变“生成中”为止排水。

## ⚠ 注意



禁止沾水

请勿水洗或用水浇主机。  
(会造成漏电, 触电)

主机或分歧栓的污垢, 请用柔软的抹布浸入用水稀释的厨房用洗涤剂(中性), 充分拧干后擦拭。

### ● 分歧栓的维护

如果分歧栓的过滤网处累积了污垢, 则会产生堵塞, 造成水量减少。

“碱性离子水·净水”, “自来水淋浴”, “自来水直流”的水量减小时, 或长期(6个月以上)使用后, 请拆开分歧栓, 用牙刷等用具清除累积在过滤网及淋浴头处的污垢。

- 拆开时, 请注意不要丢失零件。
- 组装时, 请参照图示, 顺序不要出错。

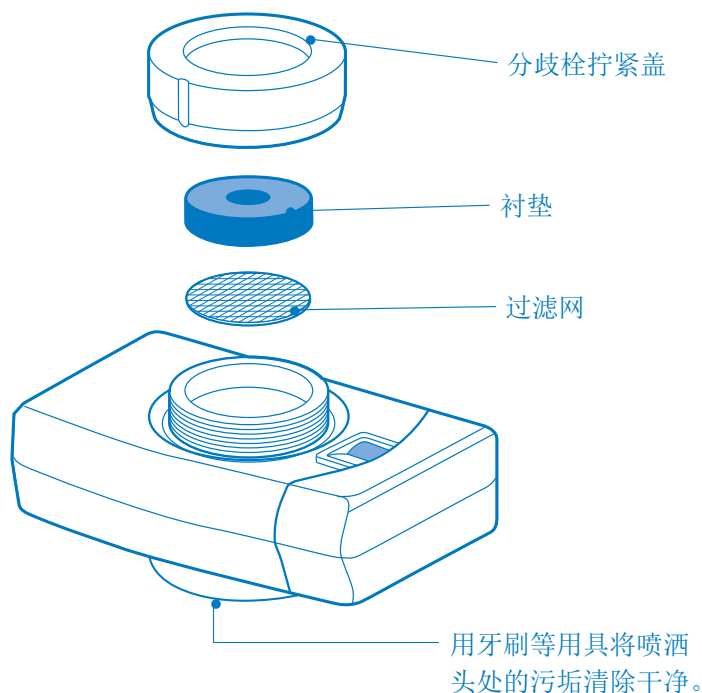

## 关于防止冻结

### 请注意

在寒冷地区自来水冻结的时期, 由于主机或供水管可能会因其中残留的水结冰而造成损坏, 所以请将水全部排出。

- 1 将碱性离子水·净水, 自来水切换开关切换到“自来水”(Raw)一侧。
- 2 将供水管从分歧栓取下, 将其放置于低于主机的位置, 将水全部排出。
- 3 将主机用毛巾等保温, 或放置于温暖的场所保管。

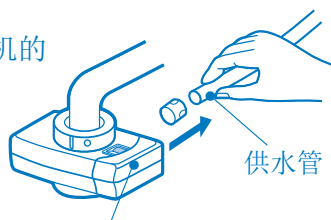

将碱性离子水·净水, 自来水切换开关切换到“自来水”(Raw)一侧。

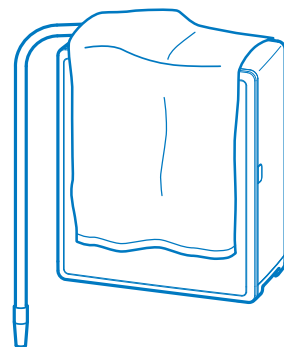

## ■滤芯的过滤性能

型号	过滤材质	可滤除物质
FW-20CM	中空纤维膜	0.1微米以上的微粒子（杂菌，红锈等）
	无纺布	粗大垃圾
	颗粒状活性炭	游离残留氯，总三氯甲烷，溶解性铅，CAT（农药），2-MIB（霉臭），四氯乙烯等
	纤维状活性炭	

## ■滤芯的使用寿命(滤芯更换指示灯的点亮条件)

- 可以使用的最大通水量：8,000L(滤芯过滤能力)
  - 可以使用天数：730天(考虑酸化方面推荐最长使用期限 约2年)
- ※可以使用的最大通水量或可以使用天数中的其一先为“0”时指示灯点亮。

### 滤芯的大概使用期限

- 一天的使用量为20L的情况下 约1年

※大概使用期限根据各家庭水质而不同。

如果您感到有异味或水量大幅减少时，即使滤芯更换指示灯未点亮也请更换。

## ■滤芯的更换时期

滤芯的更换时期，会通过液晶和滤芯的更换指示灯给予通知。(参照下表)

滤芯的更换指示灯点亮时，在使用后会发出“哔哔—”，“哔哔—”的报警音通知您更换。

### ●滤芯更换的通知报警音

到滤芯的更换时期时，滤芯更换指示灯点亮，每次使用后，会发出“哔哔—”，“哔哔—”的报警音通知您更换(10秒)。若在报警时将画面切换按钮长按2秒以上，即可停止该更换通知报警音。如果需要恢复报警音通知状态，请将电源插头重新在插座上拔插一次。

※滤芯更换后，按下重置按钮，即可恢复报警音通知状态。

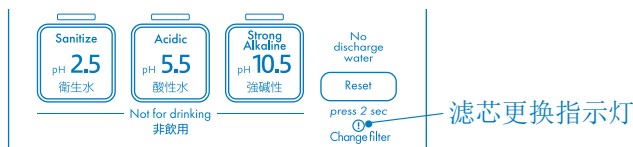

	液晶显示		
	281L以上	280L以下	0L
可以使用的最大通水量(剩余量)	281L以上	280L以下	0L
可以使用天数(剩余天数)	15天以上(液晶无显示)	14~1天前	0天
滤芯更换指示灯	熄灭	闪烁(※1) 接近更换时期。 请做好更换准备。	点亮(※2) 请更换。

※1 通水时及停止通水后，约闪烁30分钟。

※2 通水时及待机时一直亮灯。

# 滤芯的更换

## 通知

以下情况时，滤芯堵塞会较早发生。

- 根据有机物含量或水质浑浊程度不同，使用期限会非常不同。
- 井水可能会减少滤芯的使用寿命。
- 一天总使用量表示流过滤芯的水流总量，所以包含碱性离子水・排水两方面用水总量。
- 如果水中含有微粒子(浑浊物等肉眼看不见的堵塞成分)及有机物时，水量可能会大幅减少。
- 如果自来水管施工造成泥水流入，无论使用期限如何，必然会产生堵塞而导致水量减少。这种情况下，也请更换滤芯。

以下情况时，出水量可能会减少。

- 水温低的情况。(因为此时水的粘稠度增加，不易通过滤芯)
- 在水压低的地点(例如大厦的最高层等)使用的情况。
- 如果自来水管施工造成泥水流入，无论使用期限如何，必然会产生堵塞而导致水量减少。这种情况下，也请更换滤芯。

## 滤芯更换的情况

1

关闭水龙头。  
取下滤芯罩，将固定圈旋转到OPEN位置，向上拔出滤芯。  
如果拔不动时，从上面按下主机，将滤芯前后轻轻晃动后拔出。  
(滤芯底部会有水流出，请注意。)

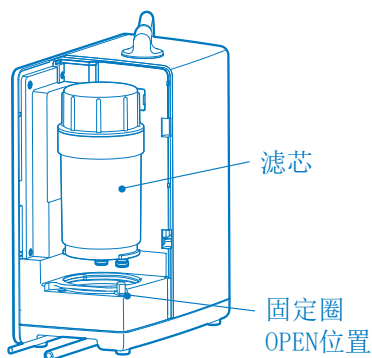

2

在主机上安装新的滤芯，将固定圈旋转到CLOSE(锁紧)位置。  
请完全插入到底。  
将滤芯管与主机孔对准后确认是否完全插入到底。

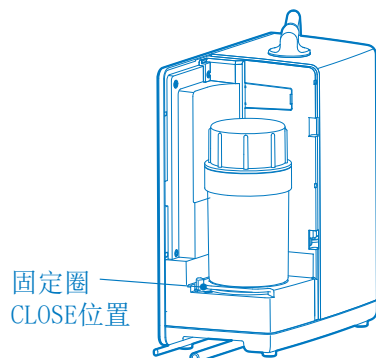

### 〈注意〉

在拔出滤芯时，滤芯中流出的水如果流主机，水会从主机底部的排水孔流出。  
请将排出的水擦干。  
产品可以继续使用。

3

关闭滤芯罩，设置为净水模式，通水直至流出的水变透明(约2~3分钟)。滤芯内活性炭的黑色粉末可能会有少量流出。

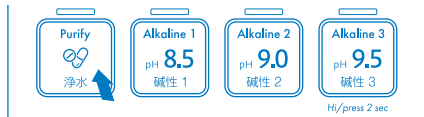

4

将滤芯更换重置按钮长按2秒以上。

报警音发出“哔—”音，滤芯更换指示灯熄灭。



# 如果出现如下显示内容时

本机拥有通过液晶显示和报警音告知机器状态的功能。  
液晶中出现如下显示内容时，请分别进行应对处理。

液晶显示	报警音	可能的原因及处理方法
	“哔，哔”鸣响	<ul style="list-style-type: none"> <li>●主机内部温度上升时，保护装置会启动，并停止生成“强碱性”，“碱性1, 2, 3”，“酸性水”，“酸化水”。(水流会继续)</li> <li>⇒关闭水龙头，稍作等待后再次使用。</li> <li>• 显示和报警音持续约10秒，之后切换成净水模式。此时净水可以使用。</li> </ul>
	“哔，哔”鸣响	<ul style="list-style-type: none"> <li>●更容易导电的水。</li> <li>⇒请先设定为净水，稍作通水后再使用。</li> <li>经过以上处理后仍不能恢复正常时，请咨询购买的经销商。</li> <li>• 显示和报警音持续约10秒，之后切换成净水模式。此时净水可以使用。</li> </ul>
	“哔，哔”鸣响	<ul style="list-style-type: none"> <li>●该水不易被电解。</li> <li>⇒请设定“Hi模式”。经过以上处理后仍不能恢复正常时，请咨询购买的经销商。</li> <li>• 显示和报警音持续约10秒，之后切换成净水模式。此时净水可以使用。</li> </ul>
(显示例) 碱性3 生成时 	“哔，哔”鸣响	<ul style="list-style-type: none"> <li>●如果在以下时间内连续生成“强碱性”，“碱性1, 2, 3”，“酸性水”，“酸化水”时，主机内的定时器启动，停止生成。</li> <li>• 显示和报警音持续约10秒，之后切换成净水模式。</li> <li>• 强碱性 ……………约10分钟</li> <li>• 碱性1, 2, 3……………约30分钟</li> <li>• 酸性水 ……………约10分钟</li> <li>• 酸化水 ……………最长约5分钟</li> <li>• Hi模式(碱性1, 2, 3)………约20分钟</li> <li>• 水素增加模式 ……………约20分钟(强碱性约10分钟)</li> <li>⇒“强碱性”，“碱性1, 2, 3”，“酸性水”，“酸化水”约40分钟稍作等待后再次使用。此时净水可以使用。</li> </ul>

	症 状	可能性原因及处理方法	参照页数
关于显示部分	无任何显示(不点亮)	● 电源插头是否脱落? ⇒请将插头牢固插入插座。	47
		● 由于是节电模式, 不使用时自动熄灭。 ⇒不是故障。重新通水可使用。 ※关水后, 30分钟以上不使用时, 所有的指示灯熄灭。	57
	通水中液晶显示区没有显示。	● 滤芯是否堵塞了? ⇒根据自来水的水质问题(浑浊物, 铁锈等), 堵塞周期会有很大差异。请更换滤芯。	67 } 69
		● 水压是否下降了? ⇒请等待至水压恢复。	—
		● 供水管是否扭曲? ⇒请将弯折处展开。	—
		● 分歧栓内是否被堵塞了? ⇒请除去分歧栓过滤网上附着污垢。	66
	滤芯更换指示灯长亮。	● 您是否忘记按下滤芯更换重置按钮了? ⇒滤芯更换后, 请将滤芯更换重置按钮长按2秒以上。	69
	滤芯更换指示灯提前点亮。	● 请确认液晶显示屏滤芯可以使用的最大通水量。 ⇒如果每天使用量较多, 则会提前点亮。	60
液晶显示“-”和“清洗(すすぎ)”闪烁。	● 更容易导电水或不易导电水。 ⇒请先设定为净水, 稍作通水后再使用。	63	

# 感觉发生故障时

	症状	可能性原因及处理方法	参照页数
关于生成水	使用pH测定液测定“碱性离子水”的pH值不变蓝色或深蓝色。	<ul style="list-style-type: none"> <li>● 这是受到了自来水中碳酸影响。水已完成电解。请参照以下方法再次确认是否含有碳酸。</li> <li>(1) 将pH值9.0的碱性离子水倒入水杯中。</li> <li>(2) 在专用杯中滴入2滴pH测定液。</li> <li>(3) 将水杯中的碱性离子水倒入专用杯中，水量至刻度线为止。此时，水在倒入的瞬间，如果先变为蓝色或深蓝色后迅速改变为绿色或黄色，则说明含有碳酸。</li> </ul>  <p>(1) 碱性离子水倒入水杯中。 (2) 在专用杯中滴入2滴pH测定液。 (3) 将碱性离子水倒入专用杯中。</p>	58 64
	使用pH测定液测试“酸化水”的pH值不变橙色。	<ul style="list-style-type: none"> <li>● 这是受到了酸化水中氯气的影响。</li> <li>⇒ 如果发出氯臭，则生成酸化水。</li> </ul>	61 64
	无法生成“酸化水”。	<ul style="list-style-type: none"> <li>● 食盐盒中的食盐是否结块了？</li> <li>⇒ 请将已结块的食盐清洗干净，并装入新的食盐。</li> </ul>	63
	生成水，净水的量变少了。	<ul style="list-style-type: none"> <li>● 滤芯是否堵塞了？</li> <li>⇒ 根据自来水的水质问题(浑浊物，铁锈等)，堵塞周期会有很大差异。请更换滤芯。</li> </ul>	67 69
		<ul style="list-style-type: none"> <li>● 分歧栓内是否被堵塞了？</li> <li>⇒ 请除去分歧栓内过滤网上附着的污垢。</li> </ul>	66
	发出臭味。	<ul style="list-style-type: none"> <li>● 滤芯的使用寿命已到。</li> <li>⇒ 请更换滤芯。</li> </ul>	67 69
		<ul style="list-style-type: none"> <li>● 是否使用了准备中的水？</li> <li>⇒ 请等指示灯点亮后再使用。</li> </ul>	56
	出现白色浮游物。	<ul style="list-style-type: none"> <li>● 是钙受到反应后形成的固体成分。</li> <li>⇒ 饮用无害。</li> </ul>	—
	流出红水(混杂了红锈等的水)。	<ul style="list-style-type: none"> <li>● 这是自来水管的铁锈，水管施工后的泥水等物质流出。(请勿饮用)</li> <li>⇒ 请将碱性离子水·净水，自来水切换开关切换到“自来水”一侧，放水直至红水全部流出。</li> </ul>	—
	将“碱性离子水”倒入水杯，可以看到闪光的浮游物，茶褐色或黑色沉淀物或浮游物等。	<ul style="list-style-type: none"> <li>● 由于pH值很高而造成溶解在水中的成分(主要是矿物质)转为水氧化物流出。(饮用无害。)</li> <li>⇒ 请降低pH值使用。</li> </ul>	56



	症 状	可能性原因及处理方法	参照 页数
在使用生成水后	铝制水壶，锅等的表面变黑。	● 加入碱性水并加热后，由于氧化而变黑。(饮用无害) ⇒请使用耐酸处理后的产品，或使用非铝制品。	—
	水壶，锅，热水瓶内附着有白色物质。	● 这是溶解于水中的钙等因为加热而产生的结晶物。(饮用无害) ⇒用热水稀释过的醋浸泡后，可清除干净。	—
	热水呈白色浑浊状。	● 这是由于pH值较高，溶解于水中的钙等因为加热而产生的结晶物。(饮用无害) ⇒请降低pH值使用。	56
	用“碱性离子水”做出的米饭，保温后呈黄色。	● 这是米中的糖分和氨基酸在热环境下反应而产生的现象。(无害) ⇒请降低pH值使用。	56
	用“碱性离子水”做出的米饭变软。	● 这是因为米中的淀粉物质，遇碱性易分解，做出的米饭可能更加软。 ⇒请降低pH值，或使用净水。	56
	排水管内侧附着黑色物质。	● 这是由于空气中的浮游菌附着在管内而产生的。 ⇒无害。不过请您用中性洗涤剂清洗或更换新排水管。	—
在使用酸化水后	“酸化水”发出氯臭。	● 这是由于清洗而产生的“酸化水”臭味。不是故障。 ⇒氯臭可能会使人不舒服等，影响人体健康，所以请充分换气。	61 5 63
其他	通水后报警音开始鸣响。	● 非饮用(自动清洗，酸化水，强碱性，酸性水)的警告音。	65
	产品主机底部有出水。	● 以防主机内部进水或更换滤芯时有水溅入，为了可以将水排除，主机底部留有小孔。 ⇒请将排出的水擦干。产品可以继续使用。	—
	主机发出“咔嚓”的声音。	● 为了维持主机的性能，在自动清洗执行后，电子部件发出的动作音。不是异常。	65

- 如果做了以上处理之后仍然不能恢复，则有可能是故障，请勿自己修理，请与您购买本商品的商家咨询处联系。
- 长期不使用时，请在清洗，干燥后，放置于湿气较低的场所保存。

# 规格

型号		HWP-77EN. HWP-77JP
额定值		AC110-240V 50-60Hz 220W
供水方式		出水龙头分歧栓
供水连接		把手切换
结构		净水器 (FW-20CM) 主机内置型
消耗电力		约220W (待机时: 约0.5W)
主机	重量	约4.1kg (满水时: 约5.1kg)
	尺寸	宽255mm×深142mm×高324mm
主机通水允许水温		35℃未滿 (分歧点是60℃未滿)
主机通水允许水压 (动水压)		70kPa~500kPa
允许水管使用压力 (静水压)		70kPa~750kPa
电解生成水量	额定水量	2.5L / 分钟 (水压100kPa, 20℃时)
	出水口水量	2.38L / 分钟 (水压100kPa, 20℃时)
	排水口水量	0.12L / 分钟 (水压100kPa, 20℃时)
	最大出水口水量	5.5L / 分钟 (水压350kPa, 20℃时)
允许连续使用时间		碱性离子水: 约30分钟 (注1) 酸性水: 约10分钟 (注1) 强碱性离子水: 约10分钟 (注1) 酸化水: 最长约5分钟 (投入15g食盐时)
过滤能力	8,000L (注2)	游离残留氯
		浑浊物 (注4)
		总三氯甲烷
		溶解性铅
		CAT (农药)
		2-MIB (霉臭)
		四氯乙烯
		三氯乙烯
		三氯甲烷
		溴二氯甲烷
		二溴氯甲烷
		三溴甲烷
		8,000L (注3)
	铝 (中性)	
土臭素		
阴离子表面活性剂		
酚类		
四氯化碳		
苯		
顺反式 1,2二氯乙烯		
过滤流量	2.5L / 分	
更换周期	FW-20CM : 约1年 (1日的使用量为20L时) (注5)	
电源线长度		2.5m
电源保护装置		保险丝 (5A)

(注1) 根据水质, 出水量, 使用环境的不同, 可能出现缩短的情况。

(注2) 根据JIS S 3201实验的滤除率为80%的值。

(注3) 净水器协会自主规格8种物质是根据JWPAS B规格测定除去率80%的试验结果。但是, 该结果并非是对铁 (粒子状铁) 和铝 (中性) 过滤能力的规定。

(注4) 根据JIS S 3201实验的过滤流量为50%的值。

(注5) 1日使用20L的情况。如果1日的使用量增加, 则更换时期会更早。

根据使用水量, 水质等不同, 可能出现较大程度缩短的情况。

# 产品中有害物质的名称及含量

部件名称	有害物质					
	铅 (Pb)	汞 (Hg)	镉 (Cd)	六价铬 (Cr(VI))	多溴联苯 (PBB)	多溴二苯醚 (PBDE)
电源基板	×	○	○	○	○	○
操作基板	×	○	○	○	○	○
制御基板	×	○	○	○	○	○
线束	×	○	○	○	○	○
电源接线	×	○	○	○	○	○
管接头	×	○	○	○	○	○
塑胶件	○	○	○	○	○	○
五金件	○	○	○	○	○	○
其它	○	○	○	○	○	○

本表格依据SJ/T 11364的规定编制。

○：表示该有害物质在该部件所有均质材料中的含量均在GB/T 26572规定的限量要求以下。

×：表示该有害物质至少在该部件的某一均质材料中的含量超出GB/T 26572规定的限量要求。

## 环保使用期限



根据 SJ/T 11364 《电子电气产品有害物质限制使用标识要求》，本标志中的数字为电子电气产品的环保使用期限的年数，标示的含义是该电子电气产品含有某些有害物质在环保使用期限内可放心使用，超过环保使用期限之后则应该进入回收循环系统。

电子电气产品环保使用期限是电子电气产品中含有的有害物质不会发生外泄或突变，电子电气产品用户正常使用该电子电气产品不会对环境造成严重污染或对其人身、财产造成严重损害的期限。电子电气的生产日期即为产品环保使用期限的起始日期。

# FUJI RYŌKI

---

FUJI MEDICAL INSTRUMENTS MFG.CO.,LTD.